

CONCRETE HANDBOOK

of Permanent Farm Construction



Mila Jackson 1919

\$ 2 50

Concrete Handbook

of

Permanent Farm Construction

The activities of the Portland Cement Association, a national organization, are limited to scientific research, the development of new or improved products and methods, technical service, promotion and educational effort (including safety work), and are primarily designed to improve and extend the uses of portland cement and concrete.

The manifold program of the Association and its varied services to cement users are made possible by the financial support of over 60 member companies in the United States and Canada, engaged in the manufacture and sale of a very large proportion of all portland cement used in these two countries. A current list of member companies will be furnished on request.

Published by

PORTLAND CEMENT ASSOCIATION

33 West Grand Avenue • Chicago 10, Illinois

The drawings in this publication are typical designs and should not be used as working drawings. They are intended to be helpful in the preparation of complete plans which should be adapted to local conditions and should conform with legal requirements.

Working drawings should be prepared and approved by a qualified engineer or architect.

TABLE OF CONTENTS

	Page
HOW TO MAKE QUALITY CONCRETE	5
Includes Information on How to Figure Quantities of Materials Required	10
CONCRETE FLOORS, WALKS AND PAVEMENTS	11
Floors in Farm Buildings	11
Concrete Walks	13
Feeding Floors and Yard Pavements	14
CONCRETE FOOTINGS, FOUNDATIONS AND BASEMENT WALLS	16
CONCRETE MASONRY CONSTRUCTION	19
Sizes and Shapes	19
How to Build with Concrete Masonry	21
Mortar to Use	22
Wall Reinforcement	22
Concrete Sills and Lintels	23
Construction at Cornice or Plate Level	24
Lightweight Concrete Masonry	24
Applying Portland Cement Paint	25
Stucco Finishes	25
WATER SUPPLY AND FARM SEWAGE DISPOSAL	27
How to Protect Wells and Springs	28
Concrete Pump Pits	29
Water Requirements	30
Concrete Cisterns	30
Stock Watering Tanks	31
Sanitary Privy	33
Farm Sewage Disposal System	34
IMPROVEMENTS AROUND THE HOME	37
Concrete Steps	37
Concrete Porch Floors	38
Concrete Flagstones	39
Lawn Furniture—Concrete Lawn Bench—Bird Bath—Flower Pots and Boxes	41
Lily Pools	44
Tree Surgery	45
Small Storage Cellar	46
Hotbeds and Cold Frames	46
Chimney Caps	47

(Continued on next page)

TABLE OF CONTENTS (Continued)

	Page
MISCELLANEOUS CONCRETE IMPROVEMENTS	48
Concrete Driveways	48
Barn Approaches	49
Concrete Loading Ramps	50
Small Farm Bridges	51
Retaining Wall Construction	52
Concrete Fence Posts	53
Corner Posts and Gate Posts	55
Electric Fences	56
Vineyard Posts	56
Clothesline Posts	56
Sign Posts for Schools, Camps, Farms	57
Mailbox Post	57
Milk Cooling Tanks	58
Ratproofing	59
Concrete Grain Bins	60
Safe Bull Pens	61
Concrete Manure Pits	62
Concrete Trench Silos	64
Dipping Vats for Cattle, Hogs and Sheep	65
Cattle Feed Bunks	66
Concrete Hog Wallow	66
Hog Trough and Automatic Waterer	67
Concrete Bases for Engines and Motors	68
Soil Erosion Control and Water Conservation	69
INDEX	71

HOW TO MAKE QUALITY CONCRETE

PROGRESSIVE farmers everywhere are turning to concrete as the most satisfactory construction material. Well-built concrete structures last indefinitely and contribute greatly to the convenience, pleasure and profit of farm living.

To be assured of maximum service and satisfaction from concrete improvements, however, it is important that concrete of good quality be made. And, it is just as easy to make concrete of good quality which gives excellent service as to make concrete of poor quality which may give disappointing results. A few simple rules carefully followed result in good concrete.

Before learning the rules for quality concrete, one should understand just what concrete is. Concrete is a mass generally composed of sand and gravel or crushed stone, the particles of which are coated and held together by a cement paste. The cement paste is made as portland cement and water are stirred together in mixing the concrete. If the cement paste is rich and strong the concrete will be strong. On the other hand, if the paste is weak and watery the concrete will be poor. Factors affecting the strength

of the cement paste and the durability of the concrete are explained below.

Water

Mixing water for concrete should be clean enough to drink.

Portland Cement

Portland cement should be kept in a dry place. Any cement containing lumps so hard that they do not readily pulverize when struck lightly with a shovel, should not be used.

Sand and Gravel*

Sand should be clean, hard and well graded, that is with particles of many sizes from very fine up to those which will pass through a No. 4 screen (4 openings per lin.in.). **Gravel** should be clean, hard and range in size from $\frac{1}{4}$ in. up to about $1\frac{1}{2}$ in. for most work. Silt, clay and loam are objectionable in sand and gravel to be used in making concrete as they coat the particles and prevent the cement paste from bonding

*Crushed stone or crushed slag may be used in place of gravel.



Good concrete sand looks like this, with sizes varying from very fine up to pebbles which will just pass through a sieve having 4 openings per lin.in.



The variety of sizes needed in a good concrete sand is illustrated by the six sizes at left which were screened out of the natural mixture of sand shown.

Good concrete gravel looks like this. Note the variety of sizes, the smaller stones filling in the spaces between the larger ones.

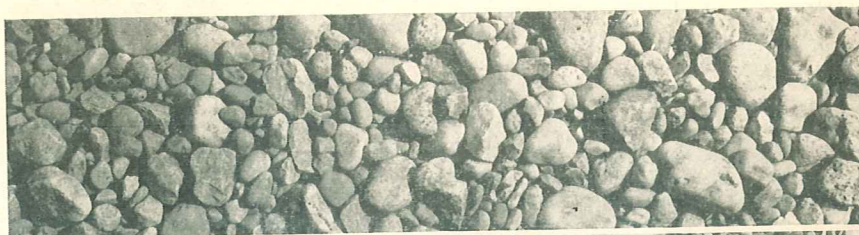

The three samples at right were obtained by screening the natural mixture of gravel shown above. Smallest sizes are $\frac{1}{4}$ in. to $\frac{3}{8}$ in.; next are $\frac{3}{8}$ in. to $\frac{3}{4}$ in.; largest are $\frac{3}{4}$ in. to $1\frac{1}{2}$ in.

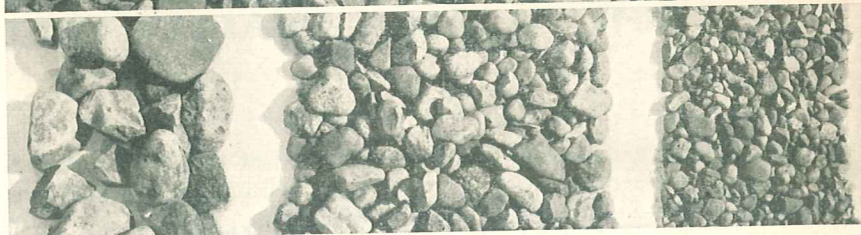

to them, resulting in weak, porous concrete. A good rule to follow is to haul sand and gravel from pits which are known to make good concrete.

Silt Test

Sand and bank-run gravel may be tested to determine whether they contain injurious amounts



The silt test quickly reveals whether or not sand or gravel is clean enough to make good concrete. This sand contains more silt than is allowable and should be washed before using in concrete.

of finely divided clay or silt as follows:

1. Place 2 in. of representative sample of sand or gravel in a pint fruit jar.
2. Add water until the jar is almost full, fasten the cover, shake vigorously, then set the jar aside until the water over the material clears.
3. Measure the layer of silt covering the sand or gravel. If this layer is more than $\frac{1}{8}$ in. thick the material is not clean enough for concrete unless washed before using.

Sand and bank-run gravel containing too much silt or clay may be washed to make them clean for use in concrete. A satisfactory washing table is illustrated in Fig. 1. It consists of a wide, shallow, sloping trough. The material is shoveled onto the high end where it is drenched with water by means of a hose or pail, washing out the objectionable silt or clay. The material should be retested after washing to make sure that it is clean.

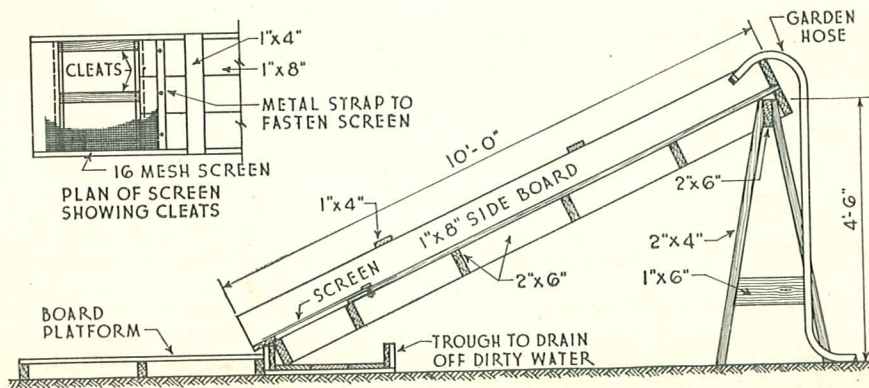

Fig. 1. Sloping table for washing bank-run gravel.

Vegetable Matter Test

Sand and gravel sometimes contain harmful amounts of decomposing vegetable matter. Concrete made with such sand or gravel may not harden or the resulting concrete may be of low strength. A test to see whether sand or gravel is fit for use in concrete may be made as follows:

1. Dissolve a heaping teaspoonful of household lye into $\frac{1}{2}$ pint of water contained in a 1-pint fruit jar. (Fruit jar should be of colorless glass.)
2. Pour $\frac{1}{2}$ pint of a representative sample of sand or gravel into the jar containing the lye water.
3. Cover the jar tightly and shake vigorously for 1 or 2 minutes.
4. Set the jar aside for 24 hours, then inspect in good light.
5. If the water is clear or colored not darker than apple cider vinegar, the material is suitable for use in concrete. However, if the color of the water is darker than this, the material should not be used for concrete before it is washed to remove the objectionable vegetable matter.

Mixing and Placing Concrete

Strong, watertight, durable concrete can readily be made by following carefully the suggestions given here. Measure all materials—water, cement, sand and gravel. It is especially important that only a limited, measured amount

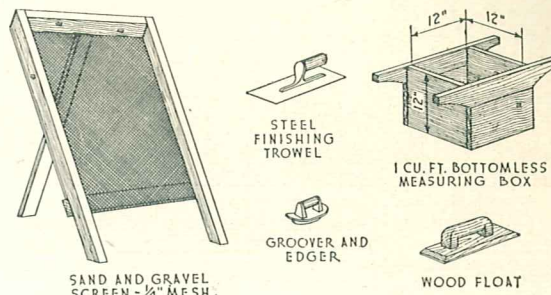

Fig. 2. Some of the tools and equipment needed for farm concrete jobs. A bottomless box holding 1 cu.ft. or 2 cu.ft. makes a convenient measure for proportioning sand and gravel.

of water be used in the concrete mix. Where too much water is added the cement paste which holds the mass of sand and gravel together will be diluted and weak. Weak cement paste means weak, porous concrete which is sure to be unsatisfactory.

Concrete materials may be measured as follows: Water is conveniently measured in a pail marked off in gallons and half gallons. Sand and gravel may be measured in a 1-cu.ft. bottomless box (see Fig. 2). Portland cement is usually obtained in sacks, each sack holding 1 cu.ft. Cement in quantities less than 1 sack may be measured as portions of a cubic foot in the bottomless 1-cu.ft. box or in pails.

Suggested concrete mixes are given in Table I. The 1:2 $\frac{1}{4}$:3 mix (1 sack portland cement to

TABLE I—Suggested Concrete Mixes*

Use of concrete	U. S. gal. of water per sack cement with average moist sand	Sand and gravel per sack cement		Largest size of gravel
		Sand cu.ft.	Gravel cu.ft.	
Most farm construction such as floors, steps, basement walls, walks, yard pavements, silos, grain bins, water tanks, etc.	5	2 $\frac{1}{4}$	3	1 $\frac{1}{2}$ in.
Concrete in thick sections and not subject to freezing. Thick footings, thick foundations, retaining walls, engine bases.	5 $\frac{1}{2}$	2 $\frac{3}{4}$	4	1 $\frac{1}{2}$ in.
Thin reinforced concrete such as milk cooling tanks, fence posts, thin floors, most uses where concrete is 2 in. to 4 in. thick.	5	2 $\frac{1}{4}$	2 $\frac{1}{2}$	$\frac{3}{4}$ in.
Very thin concrete such as top course of 2-course floors and pavements, concrete lawn furniture, most uses where concrete is 1 in. to 2 in. thick.	4	1 $\frac{3}{4}$	2 $\frac{1}{4}$	$\frac{3}{8}$ in.

*These are trial mixes for average conditions. It is particularly important to use not more water per sack of cement than shown in the table. If sand is very wet decrease amount of water used 1 gal. per sack of cement. If sand is dust dry increase amount of water $\frac{1}{2}$ gal. per sack of cement. Change proportions of sand and gravel slightly if necessary to get a workable mix.



Left—Most economical and most durable concrete is obtained only if proper amount of gravel is used in the mix. Gravel used however must be properly graded. See photograph and explanation on pages 5 and 6.



Center—A good concrete mix for most farm jobs looks like this. Note that the mix is fairly stiff, yet, because of proper proportioning there is a generous amount of cement-sand mortar to make smooth, dense concrete surfaces. There are few farm jobs that should have a wetter mix than this.



Right—Concrete floors should never be finished until the concrete has hardened enough to become quite stiff. The wood float is used for final finishing if a gritty, nonslip surface is desired. For smooth, dense surfaces, use the steel trowel for finishing.

2¼ cu.ft. sand to 3 cu.ft. gravel) is used for most kinds of farm concrete work. These are trial mixes for average conditions. Change proportions of sand and gravel slightly if necessary to get workable mixes. By a workable mix is meant one which is smooth and plastic and will place and finish well. It should not be so thin that it runs or so stiff that it crumbles. It should be rather sticky when worked with a shovel or trowel. For most work a workable mix is one which is "mushy" but not "soupy".

For machine-mixing allow 1 to 2 minutes' mixing after all materials are in the mixer. Freshly mixed concrete should be placed in the forms immediately, then tamped and spaded or vibrated to assure smooth surfaces and dense concrete. A 1x4 board sharpened to a chisel point or a garden hoe with the blade straightened out makes a satisfactory concrete spade. If an appreciable amount of water comes to the top while spading and tamping, it is a warning that the mix is too wet. To remedy a wet mix make sure that no more water is added per sack of cement than suggested in Table I. If the right amount of water is being used, a wet mix may be corrected by increasing slightly the amounts of sand and gravel in following batches.

Construction joints caused by stopping work temporarily demand special attention. Best practice is to roughen the surface with a stiff broom before it hardens. Before placing concrete again, wet the surface, then cover with a layer of cement mortar about ½ in. thick. This helps insure a tight joint between old and new concrete and

largely prevents stone pockets along the joint. Cement mortar is made by mixing 1 part of portland cement to 2½ parts of sand with enough water to make a "mushy" workable mix.

Where **hand-mixing** is employed correct proportions of materials for most small farm jobs may readily be determined by using this simple "recipe":

- ⅔ pail of water,
- 1 pail of portland cement,
- 2¼ pails of sand, and
- 3 pails of gravel

where average moist sand is used. Pails used should be of equal capacity. Usually one pail is employed only for measuring cement so that it may be kept dry; the second pail of the same size is used to measure the other materials: water, sand and gravel. If sand is very wet, water added should be reduced to about ½ pail for each pail of cement. Less water is added since the water in the sand is free to act with the cement in forming a paste.

Hand-mixing is done as follows: Place the measured amount of sand on a watertight mixing platform. Spread the cement evenly over the sand and turn the two materials with a shovel until a uniform color shows that the sand and cement are thoroughly mixed together. Spread this mixture out evenly and add the measured amount of gravel. Mix thoroughly again, then form a hollow in the material and slowly add the measured quantity of water. Mixing should continue until every particle has been completely covered with cement paste.

Concreting in Cold Weather. Mixing water, sand and gravel should be heated for concrete making in freezing weather and the new concrete should be protected from freezing for at least 3 days. Materials containing ice or frost should never be used in concrete. Concrete should not be deposited on frozen ground nor in forms containing frost or ice.

Finishing and Curing Concrete

Newly placed concrete is leveled off in the forms with a strikeboard or wood float, then the wood float is used to make an even surface. Further finishing is delayed until the concrete hardens enough to become quite stiff. If a gritty, nonskid floor is desired, a wood float is used to produce the final finish. If a smooth, dense surface is required, a steel trowel is employed in finishing.

Stony spots found when forms are removed may be patched by working a stiff cement mortar into them with a wood float. The mortar should be 1 part portland cement to 2½ parts sand.

Concrete needs moisture to harden properly, that is, to cure. New concrete should, therefore, be protected from drying out for at least 5 days. Floors and other horizontal surfaces may be covered with burlap, earth, straw, etc., and this material kept wet for the required time. Walls may be covered with canvas or burlap, etc., and this covering kept wet. Some protection may be secured by leaving forms in place

Reinforced Concrete

Steel rods called reinforcing bars, and wire mesh reinforcement are often used in concrete

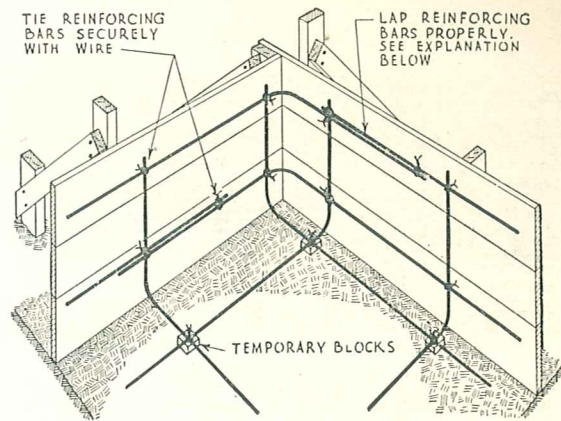

Fig. 3. Reinforcing bars should be placed as shown here. At laps bar ends should extend past each other as explained below. Reinforcement is supported on blocks to assure proper depth of concrete under the bars, then blocks are removed as concreting progresses. Always bend reinforcement around corners as shown.

to strengthen it against pulling or bending forces. Reinforcement must be free from rust scale and other coatings. Scrap iron and rusty fence wire should never be used as reinforcement. Standard reinforcing bars or mesh should be used, placed exactly in the position called for in the plans. See Fig. 3 for important steps in placing reinforcement. At laps, bar ends should extend past each other as follows:

- ¼-in. round bars—12 in.
- ⅜-in. round bars—1 ft. 6 in.
- ½-in. round bars—2 ft.
- ⅝-in. round bars—2 ft. 6 in.
- ¾-in. round bars—3 ft.

TABLE II—Approximate Amounts of Materials Required Per Cubic Yard of Concrete*

Use of concrete	Mix	Sacks of cement	Sand cu.yd.	Gravel cu.yd.	Largest size of gravel
Most farm construction such as floors, steps, walks, tanks, silos, etc.	1:2¼:3	6¼	⅔	¾	1½ in.
Concrete in thick sections and not subject to freezing. Thick footings and foundations, etc.	1:2¼:4	5	⅔	¾	1½ in.
Thin reinforced concrete such as milk cooling tanks, fence posts, slabs 2 in. to 4 in. thick.	1:2¼:2½	6½	⅔	¾	¾ in.
Very thin as for lawn furniture, top course of 2-course floors, concrete 1 in. to 2 in. thick.	1:1¾:2¼	8	⅔	¾	⅜ in.

*Amounts of sand and gravel required should be increased about 5 to 10 per cent to allow for waste and variations.

NOTE: If concrete aggregates are sold in your locality by weight you may assume, for estimating purposes, that a ton contains approximately 22 cu.ft. of sand or crushed stone; or about 20 cu.ft. of gravel. For information on local aggregates consult your building material dealer.



A small machine mixer is most convenient for farm concrete jobs of any size. Note separate piles of sand and gravel. It is particularly important to use only a limited amount of water in the concrete mix as discussed on page 7.

At laps and intersections, bars should be tied together with No. 15 or 16 gage wire. Important work should be designed and supervised by a competent engineer or contractor.

Watertight Concrete

Concrete mixes described in Table I, except the 1:2³/₄:4 mix, will make watertight concrete if all the suggested steps in construction are faithfully performed. It is particularly important that no more water be used in the mix than is specified in the table and that concrete be kept moist for a hardening or curing period of at least 7 days.

How to Estimate Quantities of Material Needed

Table II shows the amount of materials required per cubic yard (27 cu.ft.) of concrete. To find the number of cubic yards of concrete and materials for a particular job, proceed as in the following example. Suppose a concrete stock watering tank having these dimensions is to be built:

Inside, 3x9x2 ft.; outside, 4x10x2¹/₂ ft.

The over-all volume of this tank is:

$$4 \times 10 \times 2\frac{1}{2} \text{ ft.} = 100 \text{ cu.ft.}$$

The volume the tank holds is:

$$3 \times 9 \times 2 \text{ ft.} = 54 \text{ cu.ft.}$$

Subtracting 54 cu.ft. from the over-all volume of 100 cu.ft., it is found that 46 cu.ft. or approximately 1³/₄ cu.yd. of concrete is required to build the tank. As shown in Table II, 1 cu.yd. of 1:2¹/₄:3 mix concrete requires approximately 6¹/₄ sacks cement, ²/₃ cu.yd. sand and ³/₄ cu.yd. gravel. Since 1³/₄ cu.yd. of concrete is needed,

TABLE III—Approximate Amounts of Materials Required Per 100 Sq.Ft. of 1:2¹/₄:3 Mix Concrete*

Thickness of concrete	Concrete cu.yd.	Sacks of cement	Sand cu.yd.	Gravel cu.yd.
4 in.	1 ³ / ₄	7 ³ / ₄	³ / ₄	1
6 in.	2	11 ² / ₃	1	1 ¹ / ₃
8 in.	2 ¹ / ₂	15 ¹ / ₂	1 ¹ / ₃	1 ³ / ₄
10 in.	3	19 ¹ / ₂	1 ³ / ₄	2 ¹ / ₄
12 in.	3 ³ / ₄	23	2	2 ³ / ₃

*Amounts of sand and gravel required should be increased about 5 to 10 per cent to allow for waste and variables.

approximate material requirements may be found as follows:

$$1\frac{3}{4} \times 6\frac{1}{4} = 11 \text{ sacks cement.}$$

$$1\frac{3}{4} \times \frac{2}{3} = 1\frac{1}{4} \text{ cu.yd. sand.}$$

$$1\frac{3}{4} \times \frac{3}{4} = 1\frac{1}{3} \text{ cu.yd. gravel.}$$

It is best practice to increase material quantities about 5 to 10 per cent to allow for waste and variables in the work.

Amount of materials required for concrete floors, walls or other plain flat slabs of concrete may be determined from Table III which shows approximate amounts of materials needed per 100 sq.ft. of the most commonly used concrete mix, 1:2¹/₄:3. For example, concrete materials required for a poultry house floor 20x30 ft. and 4 in. thick may be computed in this way: From Table III—100 sq.ft. of 4-in. floor requires 7³/₄ sacks of cement, ³/₄ cu.yd. of sand, and 1 cu.yd. of gravel. For a floor of 600 sq.ft., as in our problem, find approximate amounts of material needed by multiplying these quantities by 6:

$$7\frac{3}{4} \times 6 = 46\frac{1}{2} \text{ sacks of cement.}$$

$$\frac{3}{4} \times 6 = 4\frac{1}{2} \text{ cu.yd. sand.}$$

$$1 \times 6 = 6 \text{ cu.yd. of gravel.}$$

Table IV can be used to estimate approximate material requirements for various thicknesses of portland cement mortar or plaster and for concrete 1 to 3 in. thick.

TABLE IV—Approximate Amounts of Materials Required Per 100 Sq.Ft. of Portland Cement Mortar or Concrete

Thickness of mortar or concrete in.	Amount of mortar or concrete cu.yd.	Mix proportions				
		1:3		1:1 ³ / ₄ :2 ¹ / ₄		
		Sacks of cement	Sand cu.ft.	Sacks of cement	Sand cu.ft.	Gravel (³ / ₈ in.) cu.ft.
³ / ₈	¹ / ₈	1	3
¹ / ₄	¹ / ₄	2	6
1	1 ¹ / ₃	2 ³ / ₄	8	2 ² / ₃	6	7
1 ¹ / ₂	1 ¹ / ₂	4	8	10
3	1	8	16	19

CONCRETE FLOORS, WALKS AND PAVEMENTS

Floors in Farm Buildings

Concrete floors are widely accepted as the most satisfactory type of floors for most farm buildings because they last indefinitely, are easy to clean and convenient to work on. Another advantage of concrete floors is that they may readily be built by the farm help if suggestions given here and in the chapter "How to Make Quality Concrete" are faithfully followed.

Before concrete is placed, the floor area should be cleared of all debris, then carefully leveled or given the desired slope. Many floors are sloped about $\frac{1}{4}$ in. in 1 ft. to drain readily. Filling placed in low spots should be tamped thoroughly to provide a firm base for the concrete slab. Floors for most farm buildings are built about 4 in. thick, 2x4 side forms commonly being used as a guide for the thickness. Floors which will receive hard or heavy usage should be built about 6 in. thick.

As shown in Table I, a 1:2 $\frac{1}{4}$:3 concrete mix is suggested for most farm building floors. The concrete mix should be rather stiff so that some tamping and spading are required in placing. The full thickness of concrete should be placed in one operation. Freshly placed concrete is leveled flush with the top of the forms by means of a strikeboard which is worked back and forth

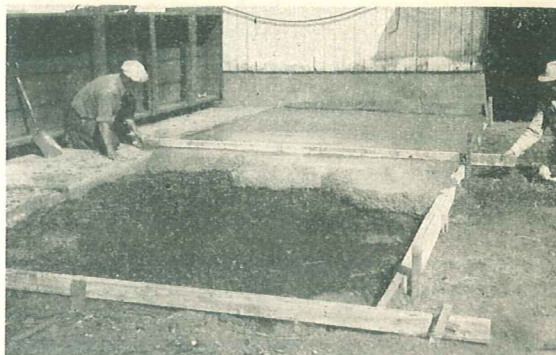

Freshly placed concrete is leveled off with a strikeboard. Note that this plastic, workable mix levels readily. 2x4 side forms are used for most floors and pavements.

across the surface with a slow, saw-like motion. A straight 2x4 about 10 ft. long makes a convenient strikeboard for large floors, correspondingly shorter lengths being used on smaller work. The new concrete is allowed to harden until it becomes quite stiff, then it is finished with a wood float and a steel finishing trowel. The wood float is used to create an even, uniform surface and it may also be used for final finishing if a gritty, nonskid surface is desired. Where a very smooth, dense floor surface is desired, final fin-

Left—After concrete becomes quite stiff but is still workable, the wood float is used to compact the surface and smooth out uneven spots left by the strikeboard. No further finishing is required on barn floors and other areas where an even, yet gritty, nonslip surface is desired.

Center—After concrete has hardened enough to become quite stiff the steel finishing trowel is employed to make a smooth, dense surface. The finishing trowel should be used sparingly since overtroweling produces surfaces which, after hardening, tend to check and dust.

Right—A broomed finish is desirable where more than normal traction is wanted to make a nonslip floor or other surface. Cattle walks and pavements are often finished in this manner.



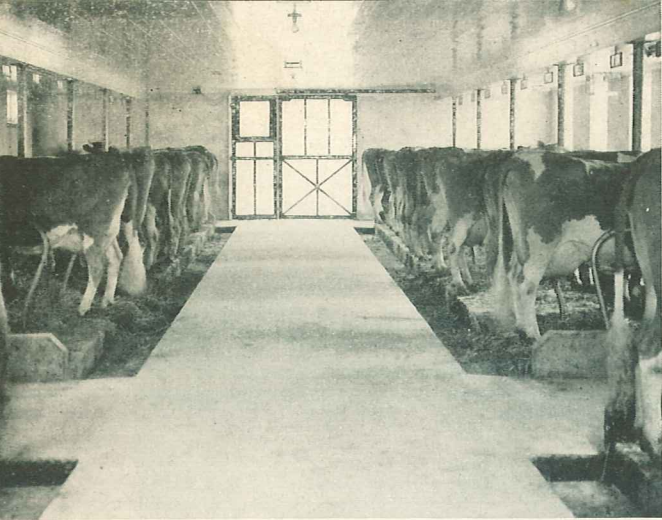

Well built concrete floors are a great convenience in all farm buildings. For specific information on how to build dairy barn floors send for free booklet on this subject.



Concrete walks to principal farm buildings help keep the house clean and are especially appreciated during wet weather.

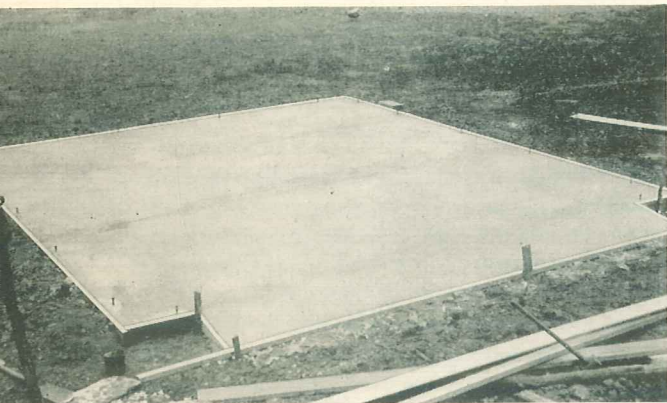

Workmanlike jobs of this kind are easily produced if care is taken to follow the few simple rules of quality concrete. Garage floors, like certain other floors, are given a slope of about $\frac{1}{4}$ in. per foot to drain quickly.

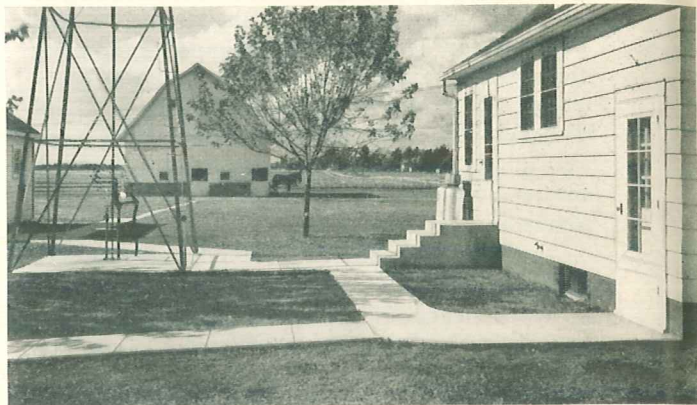

Rainy weather doesn't mean a muddy kitchen floor where concrete walks lead to the well and to the more important buildings.



Concrete sun porches help keep poultry safe from polluted water and contaminated ground.

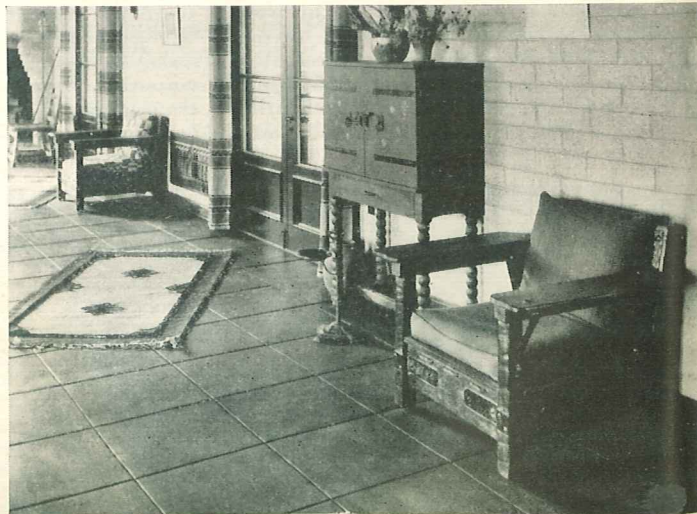

An attractive, colored concrete floor is especially practical in the farm home where firesafety and ability to withstand severe usage are so important.

ishing should be with a steel finishing trowel after the water sheen on the surface has disappeared and the concrete has become quite stiff. The finishing trowel should be used sparingly, however, because over-troweling will result in surfaces which dust and craze readily. The new concrete floor should be cured properly, as explained on page 9.

Warm, Dry Concrete Floors. In some cases a special method of construction is employed to assure dry concrete floors. Thoroughly dry floors are a necessity in grain storage buildings and in some other storage structures. Poultry house, hog house and certain other floors may in some cases require special attention to moisture-proofing. A first requirement for a dry floor is that it be placed on a site that is well-drained. If the site does not have good natural drainage, the concrete floor should be placed on a fill. Construction is then as follows:

On a well-tamped fill of gravel, cinders or crushed rock having a thickness of 6 to 12 in. above grade, place a 1½-in. base course of concrete. This thin concrete layer is then leveled and left to harden. After it has hardened, place asphalt roll roofing or tough waterproof building paper on the concrete base course, lapping and carefully cementing joints with mastic. Complete the floor by placing a top layer of concrete about 3 in. thick. New concrete floors should be allowed to age and dry out thoroughly before materials which might be injured by dampness are placed on them.

Concrete Walks

Concrete walks between important buildings are among the most convenient improvements on the farm. Construction is quite easy, the principal steps being much the same as for concrete floors described on this page and page 11.

More important walks should be 3 ft. to 5 ft. wide; less important walks 2 ft. to 3 ft. wide. Walks are usually built 4 in. thick except where heavy vehicles are driven over them, in which case the thickness should be increased to 6 in. One-course construction, that is, placement of the full 4-in. or 6-in. thickness of concrete in one operation, is suggested. A typical construction layout for concrete walks is shown in Fig. 4. Expansion joints are provided at 4 to 5-ft. intervals along the walk by placing dividing strips at right angles to the side forms. Sometimes strips of tarred felt are placed against the divider form boards, then left in place between the sections of concrete as construction progresses.

Finishing of concrete walks is accomplished in the same manner as for floors, as described on page 11, except that edges of the concrete walk are rounded by working an edging tool along the side forms. The edging tool or a combination edger and groover is also used to finish the joints across the walk where expansion strips were installed.

Construction of flagstones or stepping stones of concrete is described on page 39.

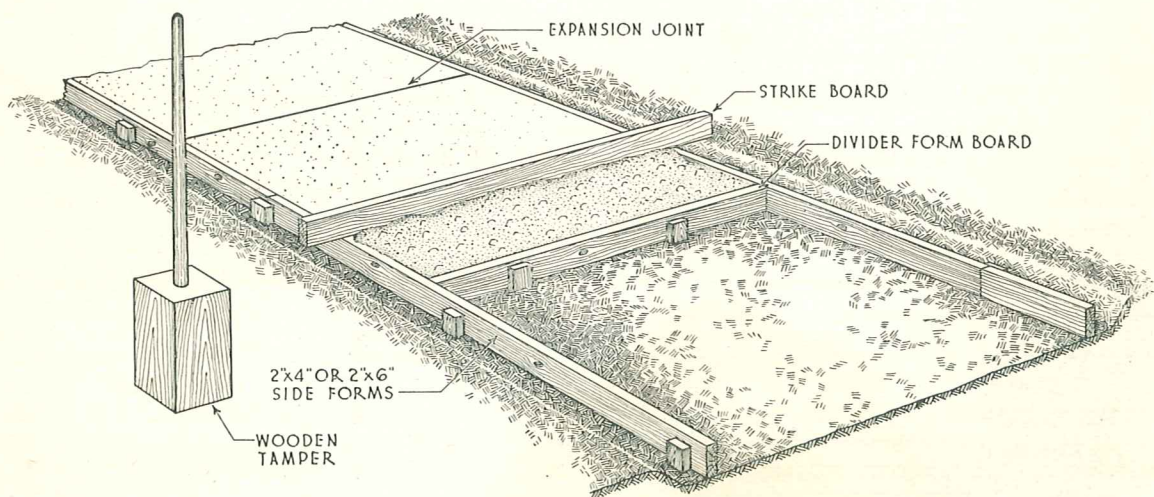
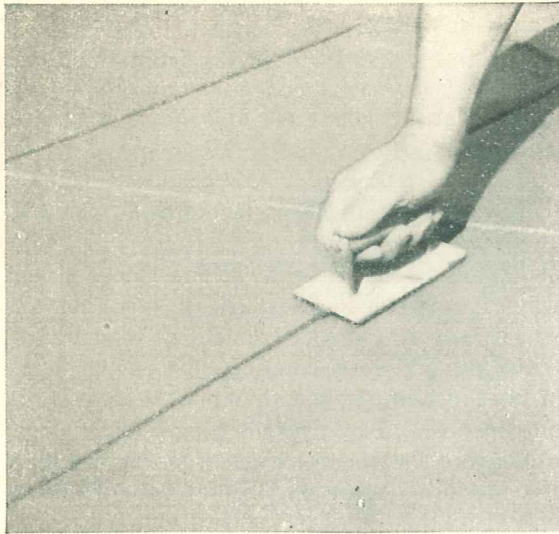

Fig. 4. Typical construction layout for building concrete walks. Concrete is often placed in alternate sections first. After these harden, intermediate sections are concreted. Tools needed in finishing are illustrated in Fig. 2.



A groover or a combination grooving and edging tool is used to mark off divisions in the concrete walk.

Feeding Floors and Yard Pavements

One of the most profitable improvements for the livestock farm is a concrete feeding floor for hogs or cattle. Many successful cattle and hog men figure that a concrete feeding floor or paved lot repays its cost during the first year of use. When cattle and hogs are fed on a paved lot, feed is not lost in mud and savings are especially large where hogs follow the cattle. Conservative livestock men report that, with hogs following cattle, the feeding floor produces an average extra profit of about \$7 per head of cattle fed. About \$2 of this profit results from added gains by the hogs when following cattle; the balance of the profit comes from faster and cheaper cattle gains, increased value of manure, savings in labor and bedding. There is little profit in late winter and early spring feeding when cattle are compelled to wade up to their knees in mud. But year around feeding can be made convenient and efficient on an inexpensive concrete feeding floor.

Since the labor of feeding and caring for hogs and cattle is an important item of cost, it is best to locate the paved lot where most efficient feeding arrangements can be made. The paved lot should also be in a sheltered location, if possible on the south side of some sheltering structure.

Size of floor to build depends upon individual requirements. If the entire feed lot or barnyard cannot be paved at one time, a strip of concrete 15 to 20 ft. wide in front of the cattle shed or hog house will be a tremendous improvement over an unpaved lot. Cattle feeders usually build 30 to 40 sq.ft. of floor per head of cattle. Feeding floors for hogs are commonly large enough to provide about 10 to 15 sq.ft. of floor per hog.

Concrete feeding floors should generally be built about 4 in. thick unless driven over with heavy vehicles, in which case they should be built about 6 in. thick. The floor should be formed in sections about 10 ft. square. If it is necessary to place the concrete feeding floor in a poorly drained location, best results are obtained by placing the concrete slab on a well-tamped fill of about 6 in. of fine stone, gravel or cinders. If the feed lot is on fairly high, well-drained soil, no fill is needed under the floor.

Steps in construction of the feeding floor are then as described on page 11 for farm building floors of concrete. It is sometimes desirable, however, to place a low curb around the edge of the feeding floor and an apron or cutoff wall extending into the ground about 1½ to 2 ft. as shown in Fig. 5. The apron or cutoff wall prevents undermining of the floor. The floor should

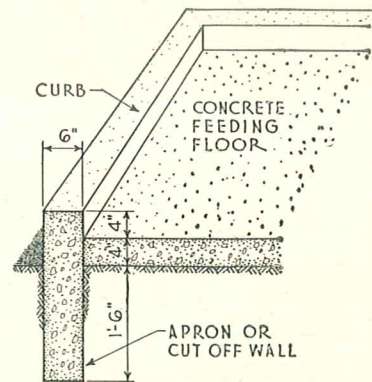
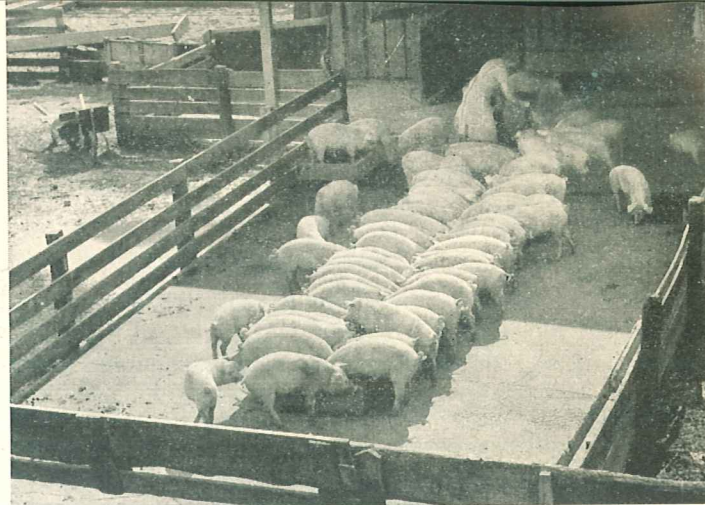

Fig. 5. Method of building curb and apron for concrete feeding floors.

be finished with a wood float to leave an even yet gritty, nonslip surface. Good floor drainage is provided by sloping the floor about ¼ in. per foot. Materials required per 100 sq.ft. of feeding floor may be determined from Table III.



The hog feeding floor is sometimes built with a slope of $\frac{1}{4}$ in. per foot so that it will clean by flushing with water from a hose.



A concrete feeding floor is one of the most profitable improvements on the livestock farm. Construction can be handled by regular farm labor. Lower cost pork is produced when hogs are confined on concrete. Information on the successful confinement system of raising hogs on concrete may be had without cost in U. S. and Canada by requesting booklet *Modern Hog Farm Improvements*.

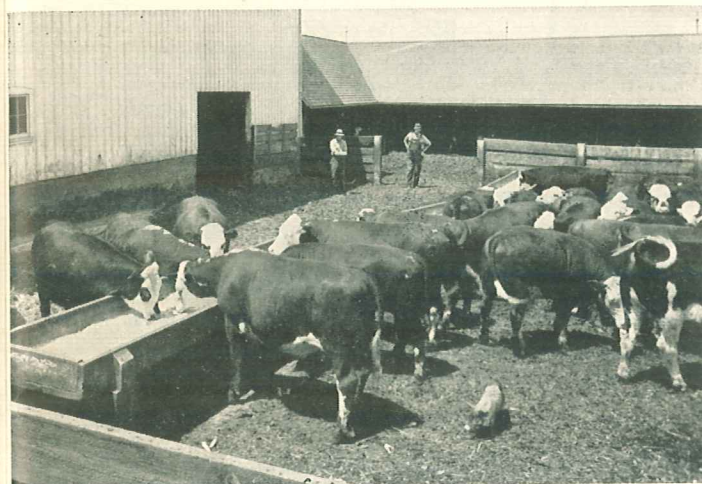

Cattle kept on concrete produce larger profits because they make cheaper gains and because there are substantial savings in feed, bedding and manure.

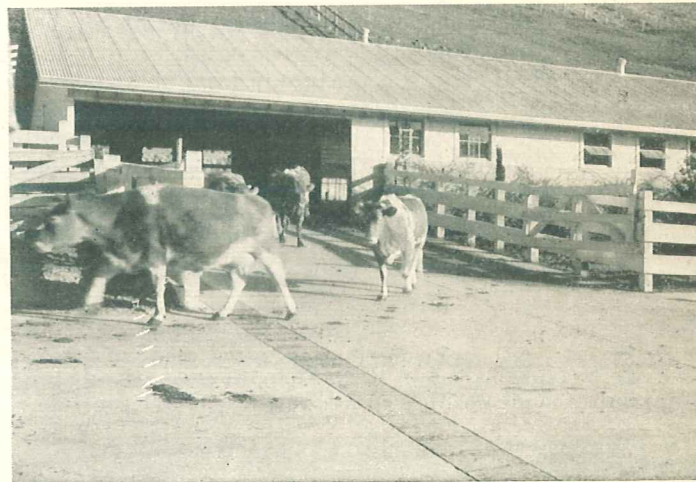

Concrete-paved barnyards are especially helpful in keeping cows clean and in producing quality milk and cream.



CONCRETE FOOTINGS, FOUNDATIONS AND BASEMENT WALLS

Footings and Foundations

Adequate, well-built concrete footings and foundation walls prolong the life of a building and reduce to a minimum danger of cracked walls and other failures which cause expensive and annoying repairs. Concrete foundations also provide permanent protection against rats, termites and rot.

Size of footings required under the foundation wall depends upon the size and weight of the building supported and also upon the type of soil encountered at the footing level. Some soils will carry much heavier loads than others. For example soft clay soil should not be loaded heavier than 1 ton per sq.ft., while firm blue clay will safely carry twice this load. In all cases the footing slab should be placed on firm soil below frost penetration. With average soil conditions (firm clay or a mixture of sand and gravel and clay) it is customary to make the footing width equal to twice the thickness of the foundation wall above. Depth of the footing is usually made equal to the thickness of the foundation wall.

Small buildings such as poultry or hog houses usually have a footing 16 in. wide and 8 in. deep

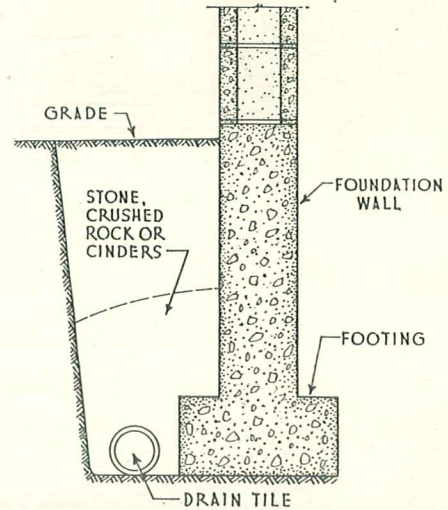
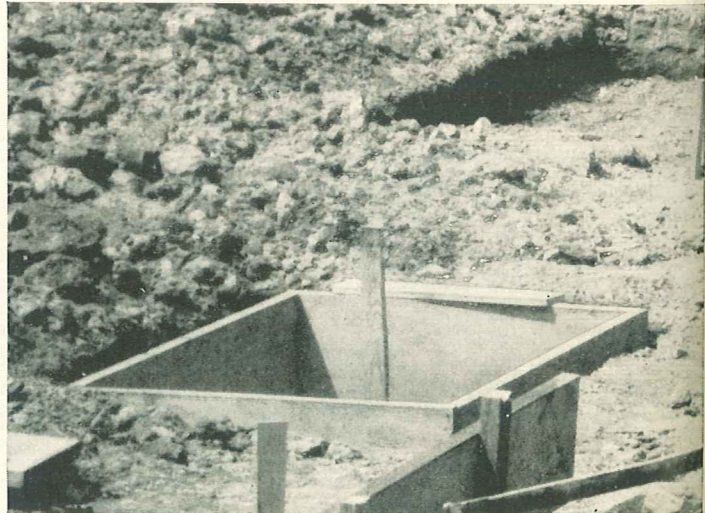

Fig. 6. Where footings are built in soft, wet soils, a tile drain should be placed entirely around the building at the footing and connected to a suitable outlet.

for average soil conditions. Larger and heavier buildings such as barns, large granaries, corn cribs, etc., should have footings 24 to 30 in.

Forms for concrete footings are often made of 2x8 or 2x10 planks as shown here. The stiff concrete mix requires some spading to assure dense, solid concrete.

Simple forms of this kind serve for concrete footings which are to support posts or piers.



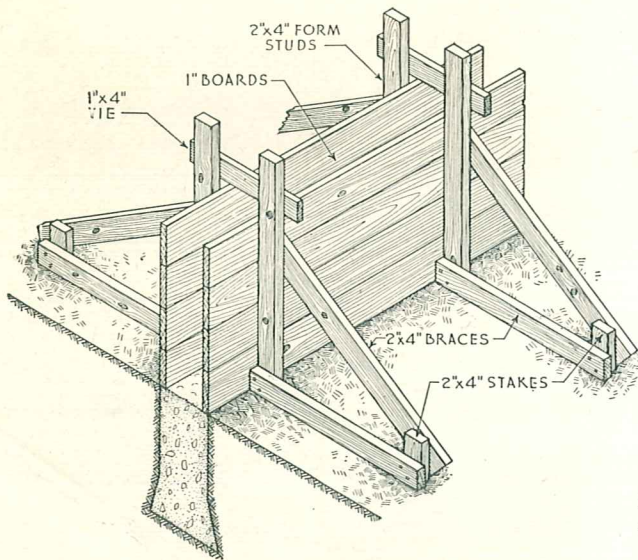

Fig. 7. Foundation walls above grade may be formed in this manner where earth walls of the trench stand straight and true, and where a wide footing is not required. Most foundations should have a footing, however, in which case the foundation is formed as shown in Fig. 8.

wide and about 12 in. deep. Where very soft clay, muck or quicksand is encountered, width of footing should be doubled and best practice is to provide tile drainage around the footing.

Footing slabs under posts and columns demand special attention. Posts and columns in

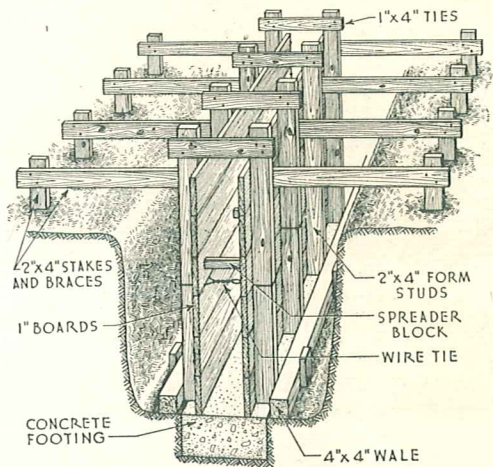

Fig. 8. Suggested method of forming for foundations which are supported on footings.

many farm buildings support heavy loads and it is important that the footing area be great enough to prevent settlement of the post and consequent sagging of the structure above. Post footings in small buildings and for light loads may be built 1½ to 2 ft. square and 9 to 12 in. thick; for heavy loads such as those found in large or heavily loaded barns, grain storages, etc., the footing should be 2½ to 3 ft. square and 12 to 15 in. thick.

Forms for foundation walls above grade are shown in Figs. 7 and 8. Forms should be rigid and well braced in order to withstand the pressure of wet concrete and produce a straight, even wall without bulges. Wet concrete weighs around 150 lb. per cu. ft. Form sheathing, as well as posts and studs, must be strong enough to withstand pressure due to this weight. Forms are usually of 1-in. boards backed up with 2x4 or 4x4 studs, spaced about 16 in. apart. Opposite sections of forms are tied together with wires looped around each opposite pair of form studs. Ties are ordinarily spaced about 24 in. apart along the stud and may consist of single strands of No. 9 or No. 10 gage soft iron wire or doubled strands of No. 12 wire. Small spreader or spacer blocks, cut in lengths equal to the thickness of the wall desired, are placed in the forms and the wire ties are then twisted to hold the spreaders tightly in place. These spreader blocks must, of course, be removed as filling of the forms with concrete progresses. Form faces may be painted with engine oil to prevent concrete from sticking.

Forms should be so constructed that they can be taken down without damage if desired to reuse.

Forms for high concrete walls must be adequately braced to assure straight, plumb walls.

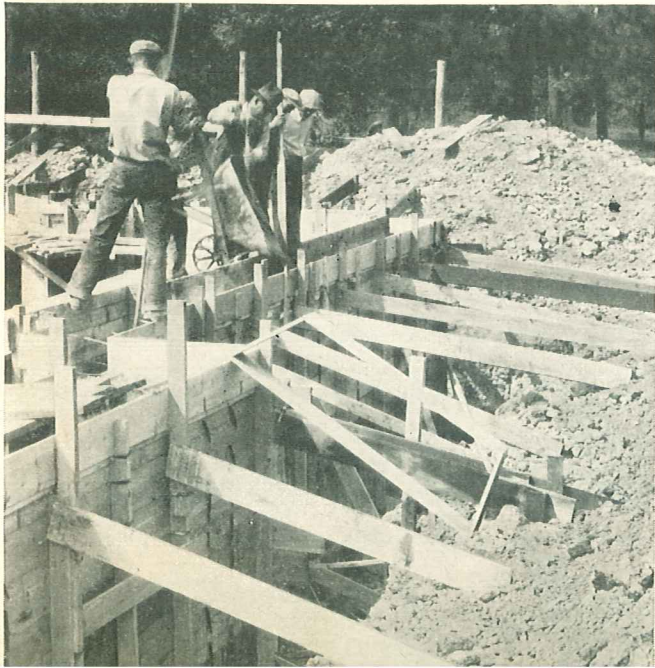

Correct concrete mixes for footings and foundations are given in Table I. Best results are obtained when a rather stiff mix is used. Concrete should be placed in the forms in layers not deeper than 6 in. and if possible the complete wall should be cast in one continuous operation. If it is necessary to interrupt the work, however, construction joints should be given special treatment as described on page 8.

Watertight basement walls are readily built if certain precautions are taken. Quality concrete and first class workmanship are perhaps the most important factors. A worth-while precaution to insure a dry wall is to place a line of drain tile entirely around the building at the footing level as shown in Fig. 6. The tile line should slope at least 1 in. in 25 ft. and should lead to an adequate outlet. Coarse material such as crushed rock, cinders or stone should be placed over the tile to a depth of at least 18 in. to permit quick drainage.

In building dry basement walls of concrete masonry, it is good practice to apply two coats of portland cement plaster on the exterior surface. The plaster mix should consist of 1 sack of portland cement to $2\frac{1}{2}$ cu.ft. of damp mortar sand. Each coat should be about $\frac{1}{4}$ in. thick. The first coat is scratched or roughened before it hardens to provide good bond for the second coat. The second coat may be applied on the day following the first coat. Keep plaster moist for several days by frequent sprinkling. After plaster coats have hardened, an asphalt coating can be applied as an additional protection.



Thorough spading of concrete along form faces helps assure smooth, watertight concrete walls.

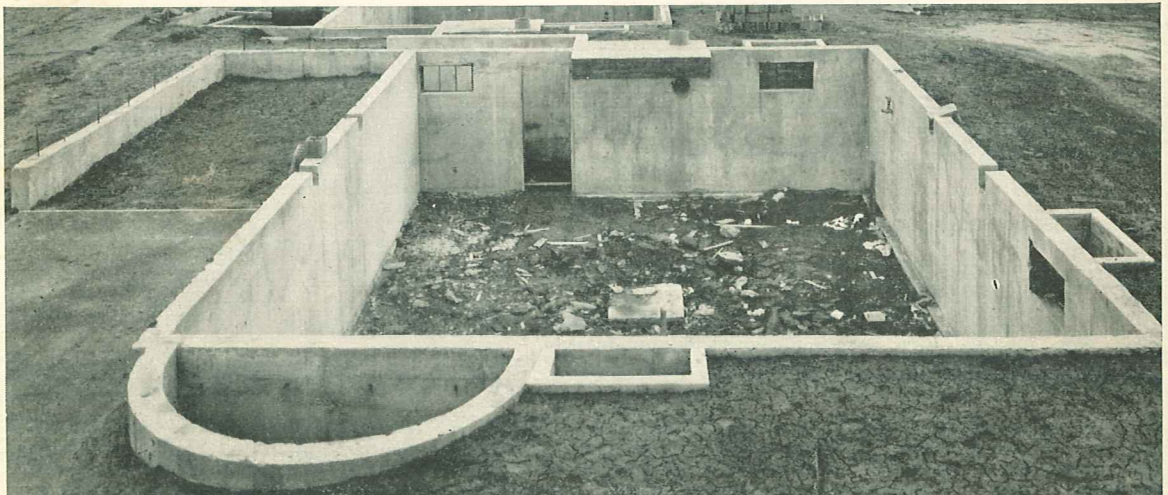

Quality concrete and well built forms help produce smooth, attractive basement walls of cast-in-place concrete.

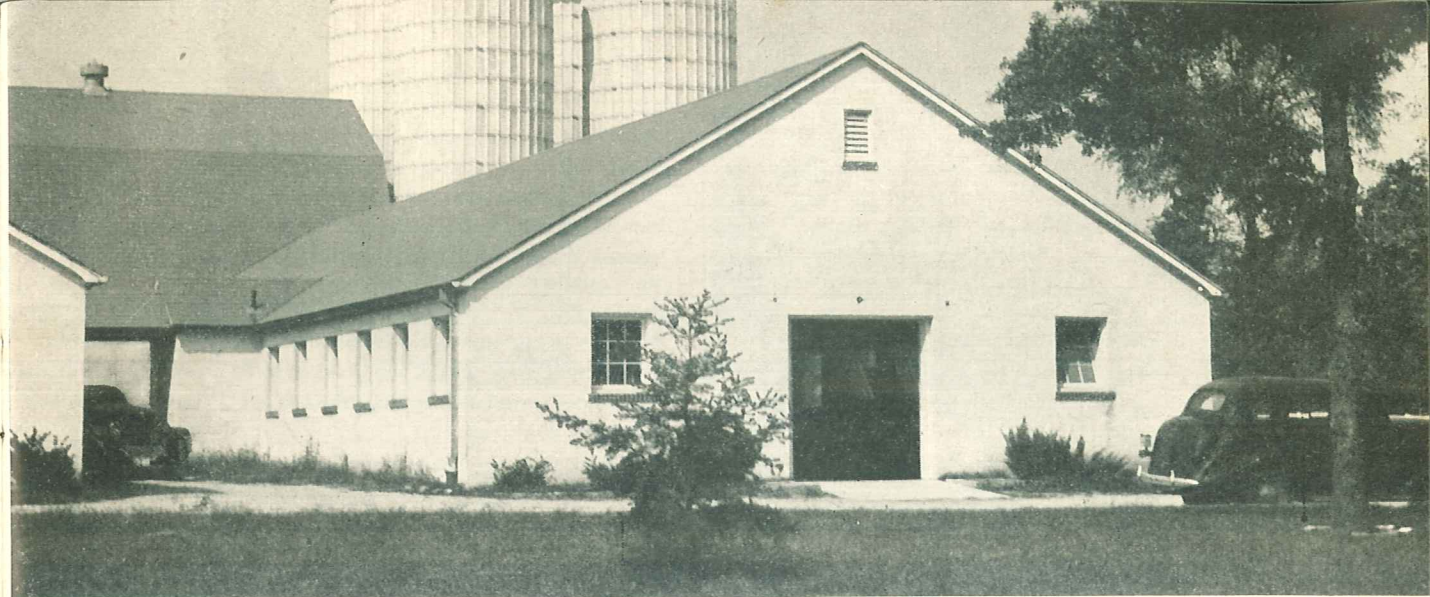

Attractive farm buildings of concrete block or concrete building tile are secured when a few simple rules of good concrete masonry construction are followed.

CONCRETE MASONRY CONSTRUCTION

Concrete masonry units, that is, concrete block, concrete building tile and concrete brick, are widely used in constructing all types of farm buildings. The growing popularity of concrete masonry construction for farm structures is due to its economy, durability and firesafety—these advantages mean low maintenance costs and long life. Concrete masonry farm buildings also present a neat, attractive appearance which is a real asset. Masonry units are readily obtainable from local concrete products manufacturers.

Sizes and Shapes

Concrete blocks are made in several convenient shapes and sizes. The nominal 8x8x16-in. concrete block is the size most commonly used. It is laid in courses 8 in. high and makes a wall 8 in. thick. In some areas other sizes are in com-

mon use. Your local concrete block manufacturer will be glad to furnish information on the sizes and shapes of units he makes. Most block manufacturers carry in stock corner units, jamb units, half-length units, and other specials which enable the mason to construct neat, attractive walls.

How to Build with Concrete Masonry

In general, it is best to employ an experienced mason to build concrete masonry walls, especially for more important structures. In small, less important jobs any man handy with tools can acquire the experience necessary to lay concrete masonry units. The mason should follow these simple suggestions:

1. Check the footing or foundation wall to see that it is level and straight, then stretch

Wall finishes for concrete masonry buildings may be varied to suit individual tastes. *Left*—Light colored portland cement paints are sometimes applied to enhance the appearance. *Right*—A white or light colored mortar contrasts with the darker block to produce an interesting effect.

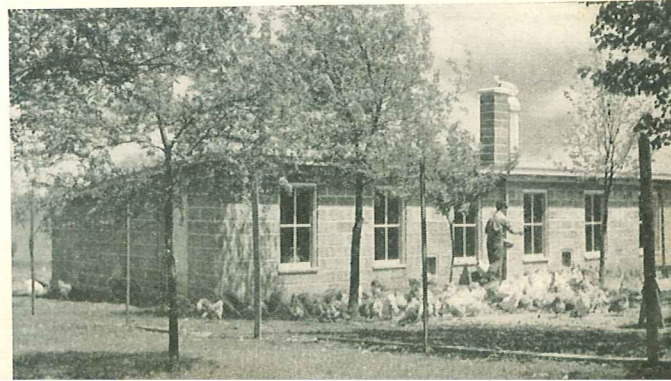
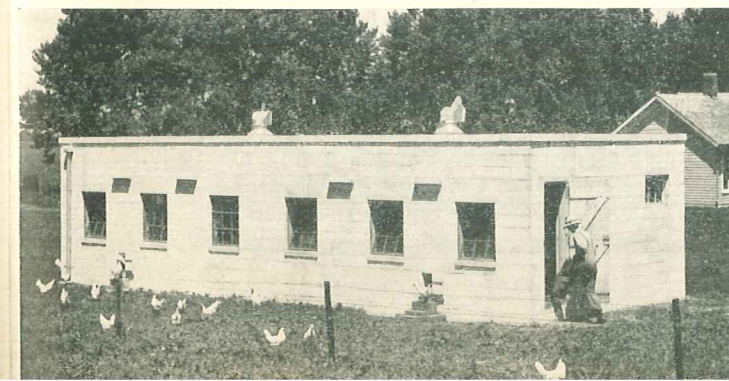

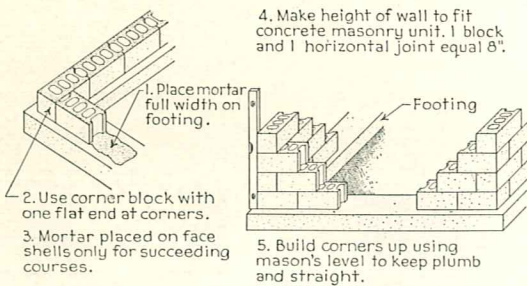

FIG. 9 (A) START LAYING BLOCK AT CORNERS

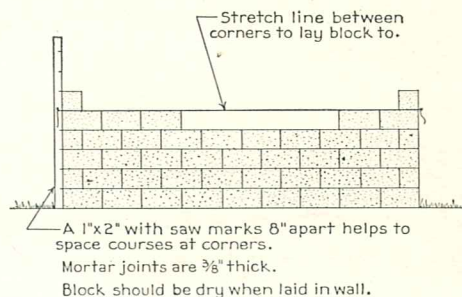

FIG. 9 (B) BUILD WALL BETWEEN CORNERS

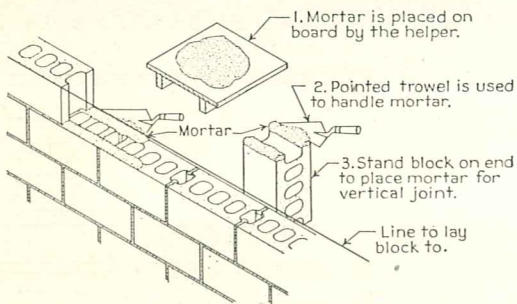

FIG. 9 (C) APPLY MORTAR IN A DOUBLE ROW

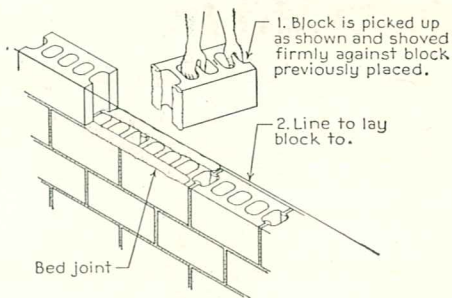

FIG. 9 (D) SET BLOCK FIRMLY IN PLACE

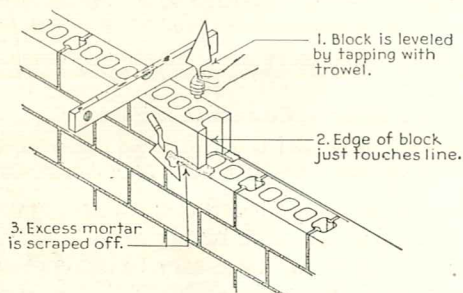

FIG. 9 (E) LEVEL BLOCK AND SCRAPE OFF EXCESS MORTAR

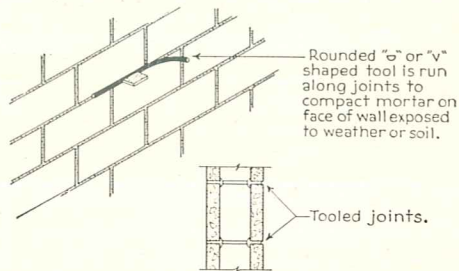

FIG. 9 (F) TOOL THE JOINTS TO COMPRESS MORTAR

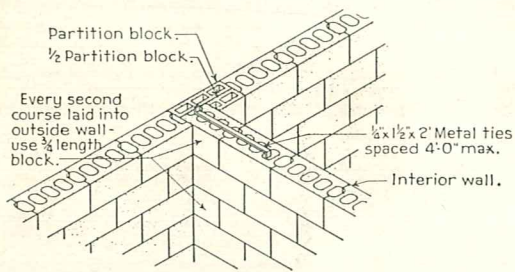

FIG. 9 (G) BUILD PARTITION WALLS INTO OUTSIDE WALLS

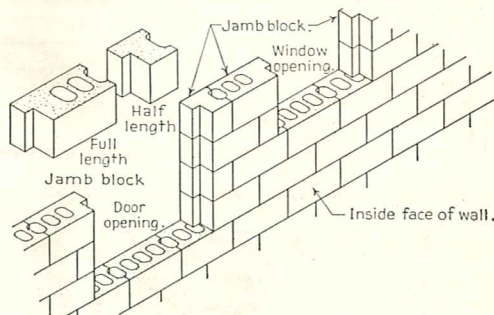

FIG. 9 (H) USE RECESSED JAMB BLOCK AT SIDES OF DOOR AND WINDOW OPENINGS

Fig. 9. Good masons use methods illustrated here to build strong, durable concrete block walls.

chalk lines to serve as guides in building the corners.

2. Build corners 3 or 4 courses high as shown in Fig. 9(A), then lay up the walls between corners. Use a chalk line stretched between corners as shown in Fig. 9(B) to serve as guide in building the walls.
3. For the first course of block place mortar the full width of the block wall, as shown in Fig. 9(A). For other courses place mortar in a double row on the block already laid. This method of placing the mortar, illustrated in Figs. 9(C) and 9(D), is called "face shell bedding".
4. Butter one end of the block with mortar, Fig. 9(C), and shove firmly against the unit previously placed, Fig. 9(D). Level and plumb the block and scrape off excess mortar squeezed out between the joints, Fig. 9(E). Horizontal and vertical joints should average $\frac{3}{8}$ in. thick.
5. After the mortar has become quite stiff, run a pointing tool of the type shown in Fig. 9(F) along the mortar joints. This compacts the mortar and helps make tight, strong joints.
6. Where cross walls and partitions intersect outside walls, use the type of construction shown in Fig. 9(D). This makes a strong connection and helps stiffen the building.
7. Use recessed jamb block around door and window openings as illustrated in Fig. 9(H). The jamb block shown is used for door frames, and for both wood and steel window frames. After the masonry and other rough construction work is completed, install door and window frames. Small door openings in service buildings can be framed with 2x6-in. material as shown in Fig. 10. Use corner block instead of recessed jamb block for the sides of such openings.
8. For greatest convenience in laying 8x8x16 block, make width of window and door openings and distances between openings an even multiple of 8 in. Then standard full- and half-length units can be used without cutting.
9. Store concrete block under cover so they will remain dry until placed in the wall.

Some very interesting wall finishes can be obtained by varying the treatment of the mortar joints. A simple yet attractive finish is produced by tooling the horizontal joints to make them

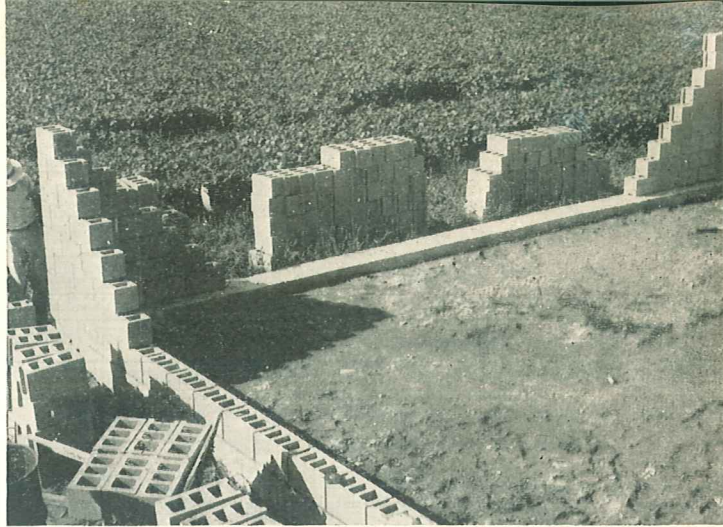

Steps in Building Concrete Masonry Wall.

Above—Corners are built up first on a wide concrete footing, after which the walls in between are erected.

Below—Vertical edges of the blocks are buttered with cement mortar.



Below—Block is held in this manner in placing. The block is then shoved firmly against the one previously placed, care being taken to set the block level.

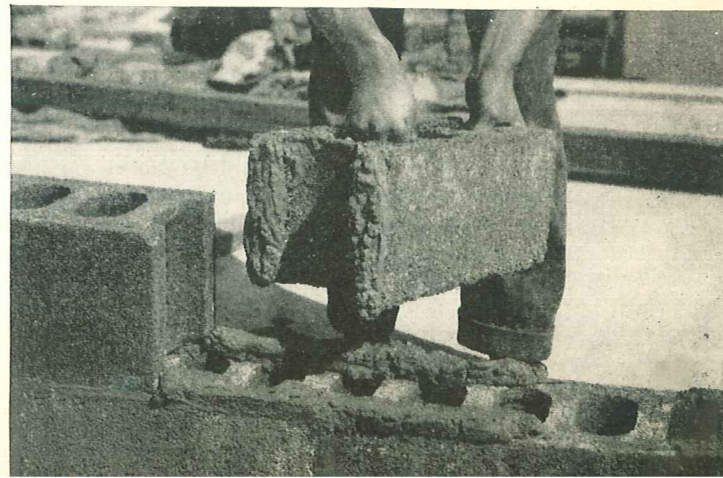

TABLE V—Materials Required for 100 Sq. Ft. of Concrete Masonry Wall

	8-in. course height	5-in. course height	3½-in. course height
Wall thickness	4-in. or 8-in.	4-in. or 8-in.	4-in. or 8-in.
Number units (block)	110	220	300
Mortar, cu.ft.	3¼	5	6

stand out prominently and by cutting off the vertical joints flush with the wall surface, then rubbing them with a piece of carpet, cork or other rough material to give them about the same texture as the concrete masonry units. Then when the wall is painted with portland cement paint the attractive finish with bold horizontal lines shown in illustration on page 25, is obtained.

Mortar to Use

Concrete masonry walls should be laid up with a mortar composed of one of the proportions given in Table VII, depending upon the type of wall to be constructed.

TABLE VII—Proportions by Volume

Type of wall	Cement	Hydrated lime or lime putty	Mortar sand in damp, loose condition
Ordinary	1 masonry cement* or 1 portland cement	2 to 3
		1 to 1¼	4 to 6
Subject to extremely heavy loads, violent winds, earthquakes or severe frost action. Isolated piers	1 masonry cement* plus 1 portland cement or 1 portland cement	4 to 6
		0 to ¼	2 to 3

*Federal Specifications SS-C-181-b, Type II.

A full bed of mortar should be placed on the footing to receive the first course of block. Face-shell bedding should be used on all succeeding courses with full mortar coverage on vertical and horizontal face shells. Joints should be ¾ in. thick. Joints should be firmly compacted after the mortar has stiffened, with a rounded tool

TABLE VI.—Materials Required for 100 Cu.Ft. of Mortar

Type of mortar	Sacks of cement	Lime cu.ft.	Sand (damp loose) cu.yd.
1 vol. portland cement or 1 vol. masonry cement to 3 vol. sand	32	...	3.5
1 vol. portland cement to 1 vol. masonry cement to 6 vol. sand	16 p.c. and 16 m.c.	...	3.5
1 vol. portland cement to 3 vol. sand plus ¼ vol. lime	29	6.7	3.5

having a diameter slightly larger than the thickness of the joint.

Wall Reinforcement

Ordinarily it is not necessary to place steel reinforcement in concrete masonry walls of small buildings. However, it is often considered good practice to place two ¼-in. round reinforcing bars in the horizontal mortar joints, especially in the courses of masonry just below and just over windows and in the joint between the top and the second from the top courses of block under the plate. These bars give added strength to the walls at these points. Bars are placed in the beds of mortar along the face shells as shown in the photographs at the right. At laps, bar ends should extend 12 to 15 in. past each other.

Below—Reinforcing bars should be bent around corners, laps being made well away from the corners. Note that bars are lapped 12 to 15 in.

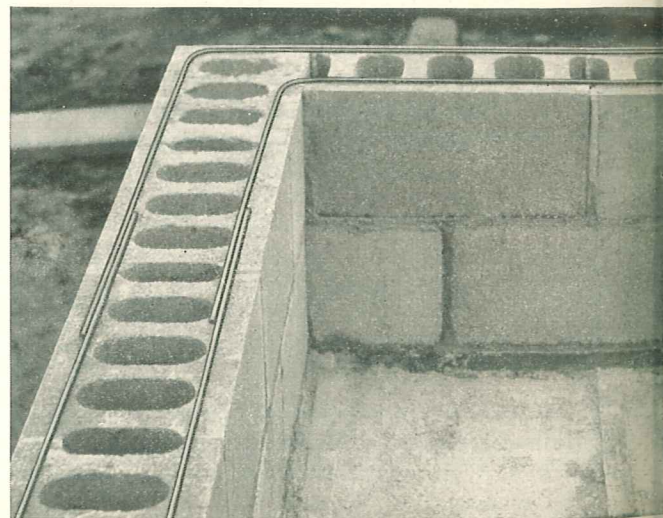

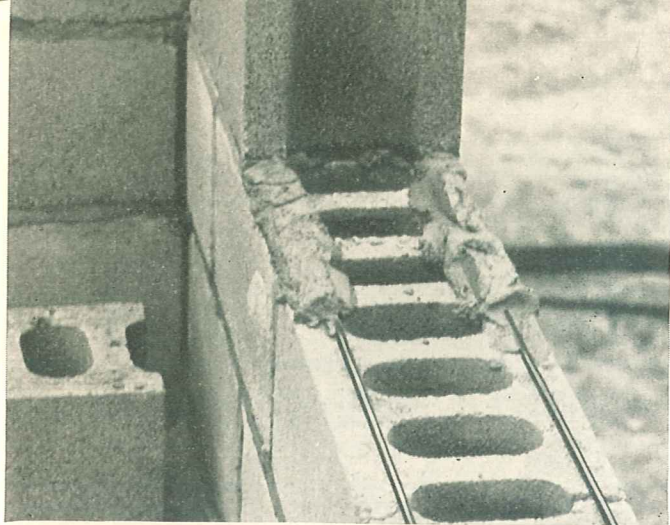

Above— $\frac{1}{4}$ -in. round reinforcing bars are sometimes placed in mortar joints.

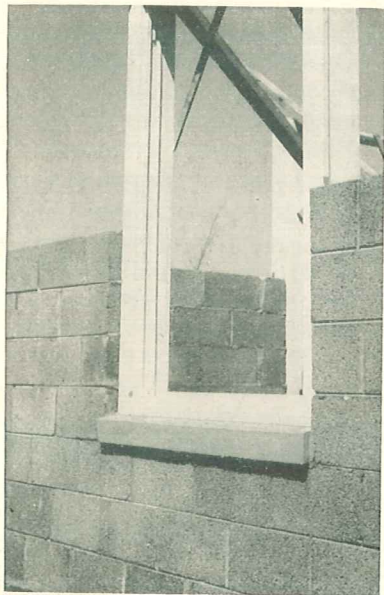

Concrete window sill built into concrete masonry wall.

Concrete Sills and Lintels

Common shapes of concrete lintels are shown in Fig. 11. One-piece lintels are used for most farm service buildings, but the two-piece lintel is sometimes used in farm house construction. Fig. 12 shows the two types of lintels in place over wall openings. It will be noted in Fig. 11 that the lintels are recessed so that window and door frames can be installed after masonry work is completed. For openings not framed and interior partition doors, lintels without recesses are generally used. Both types can be either cast in place or precast. Reinforcement needed in the lintel depends on the width of the opening and the loads carried. Lintels 3 to 8 ft. long, which carry only wall loads, are usually reinforced with two $\frac{3}{8}$ -in. round bars in the positions indicated in Fig. 11. Extra reinforcement is needed when lintels are longer or when they carry both wall and floor loads. In these cases, it is best to obtain the advice of a structural engineer.

Two types of concrete sills are shown in Fig. 11. The sill for steel sash has a raised shoulder to support the window frame. A groove or drip cast into each type of sill helps keep window drainage from staining the wall below.

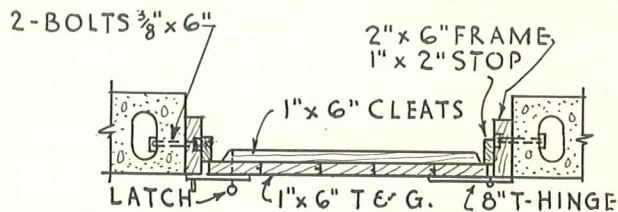

Fig. 10. A method of building door frames which is suitable for most service buildings.

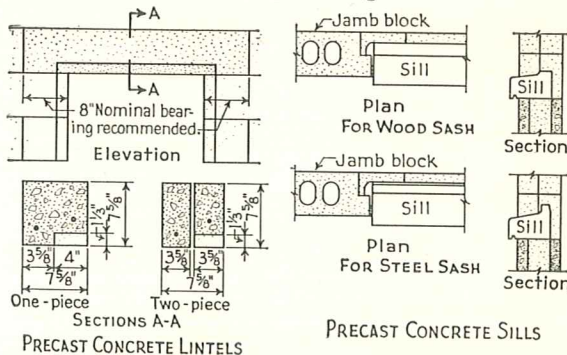
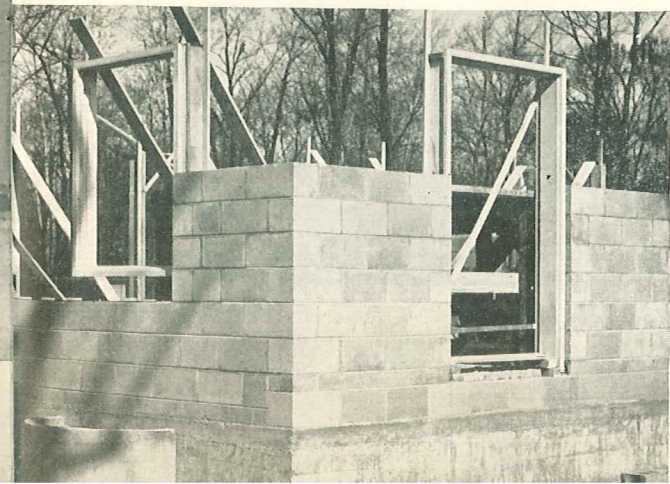

Fig. 11. Typical details of concrete lintels (left) and concrete sills (right).



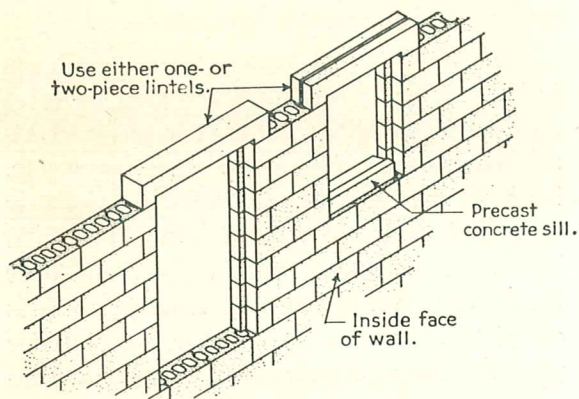

Fig. 12. Two types of concrete lintels.

Construction at the Cornice or Plate Level

The usual method of fastening the plate is shown in Fig. 13. A $\frac{1}{2}$ "x18-in. bolt is mortared into the block at 4-ft. intervals. Metal lath in the second mortar joint under the core to be filled supports the bolt and mortar while filling the core. Two thicknesses of 2x6-in. or 2x8-in. material are bolted down for the plate. Walls should always be braced by crossies at plate level as in Fig. 13

Lightweight Concrete Masonry

With more and more attention being given to well-insulated homes and livestock buildings, many farmers are building with lightweight insulating concrete block and tile. These are made from concrete with such aggregates as cinders, expanded slag and expanded burned shale. An insulated wall 8 in. thick can be built with 8x8x16-in. lightweight block. If more insulation is needed, cores can be filled during wall construction with granular insulating material as shown in the photograph at right.

Another type of insulated wall construction is shown in Fig. 14. This consists of a 10-in. double wall of 4x8x16-in. nominal size block with a $2\frac{3}{8}$ -in. air space between. The walls are tied together with the No. 6 gage metal ties described in Fig. 14. Further insulation can be obtained by filling the air space with granular insulating material.

When loose fill insulation is used the inside face of the wall should be painted with a vapor sealing material to keep insulation dry. Aluminum paint is used to seal the wall surface. Two to

three coats are needed to secure an adequate covering. The outside surface of the wall is made weathertight by the application of two coats of

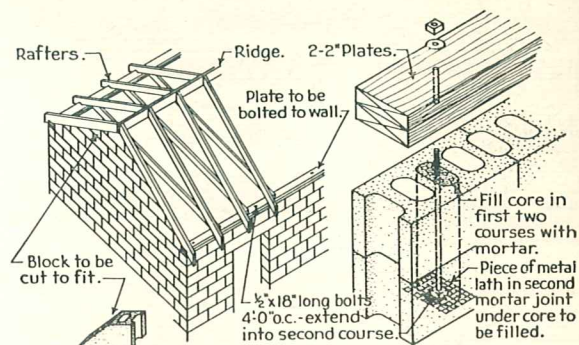

Fig. 13. Attaching rafter plate and laying block for gable ends in concrete masonry buildings.

portland cement paint as described on the following page. Painting the inside and outside surface is the means used to reduce possibilities of insulation getting wet and reducing its insulation value.



Increased insulation of concrete masonry walls may be provided by filling cores in the units with a granular insulating material.

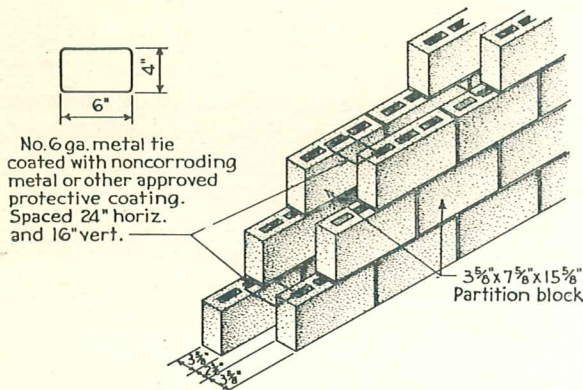

Fig. 14. Ten-inch cavity wall of concrete masonry.

Applying Portland Cement Paint

Concrete masonry walls take on an attractive, fresh, clean appearance when painted with portland cement paint (see photograph above right). Portland cement paint is sold in dry powdered form ready for mixing with water. It is generally made with white portland cement, and lime-proof and sunproof mineral pigments which are ground with other materials to produce the colored product. A wide range of colors can be obtained, especially if the standard available colors are blended.

Portland cement paint should be distinguished from other cold water paints. Many of the latter are referred to as cement paints although they contain little or no portland cement and are made up largely of hydrated lime, casein, glue or other materials. Some of these materials offer little resistance to weather or other adverse conditions and serve only as temporary color coatings when exposed to these conditions. For outdoor use and locations subject to moisture, only paints which the manufacturer can definitely show to have satisfactory service records under similar conditions should be used.

Portland cement paint is easily applied and bonds with any properly prepared concrete surface, concrete masonry or portland cement stucco, common brick, soft tile, limestone, or any other type of masonry which presents a clean surface having some absorption.

To be assured of best-quality portland cement base paint purchase it from a reputable paint manufacturer who can assure you that the paint conforms to the requirements of *Federal Specification for Paint; Cement-Water, Powder, White and Tints (For Interior and Exterior Use)*, Serial Designation TT-P-21. This specification states that where portland cement base paint

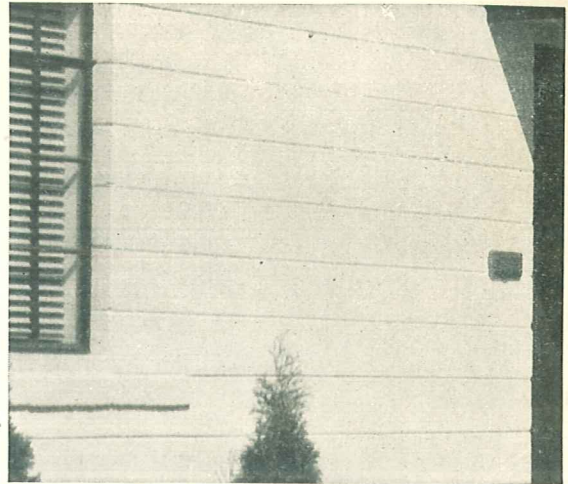

Tooling of horizontal mortar joints followed by an application of waterproofed portland cement paint produces this attractive, modern appearance.

is applied to open-texture surfaces, such as light-weight aggregate concrete masonry units, the adding of 15 to 40 lb. of fine siliceous aggregate (No. 100 to No. 20 sieve) to 60 lb. of the basic paint powder is permitted. This fills pores in block and helps to make the wall watertight.

Portland cement base paints should be applied according to manufacturers' recommendations with scrub brushes or fender brushes which permit scrubbing the paint into the pores of the surface being painted. Keep the painted surface in a moist condition for at least 48 hours following application. A fine water spray may be applied as soon as the paint has hardened sufficiently to prevent damage, and at sufficient intervals thereafter to keep it moist. New concrete masonry walls should be allowed to age for at least 4 weeks before painting.

Additional information on painting concrete masonry is available by requesting *Application of Portland Cement Paint on Exposed Concrete Masonry Wall* (free in U. S. and Canada).

Stucco Finishes

If the owner prefers, he may have his concrete masonry buildings finished with portland cement stucco. Stucco finishes can be produced in a wide selection of textures and colors. A few typical textures are illustrated on the next page.

Concrete masonry walls provide an unexcelled base for stucco—the stucco mortar adhering to it readily and permanently. Three-coat work is

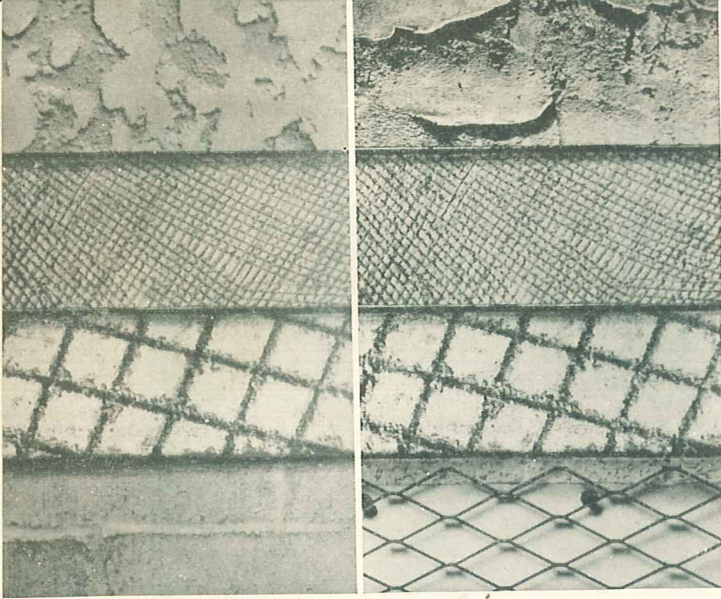

Left—Portland cement stucco is readily applied directly on concrete masonry walls. Scratch coat, second coat and finish coat are shown. *Right*—In the case of frame construction, portland cement stucco should be applied to expanded metal lath properly secured.

recommended, consisting of a first or scratch coat, a second or brown coat and a finish coat. The first two coats are each about $\frac{3}{8}$ in. thick and the finish coat from $\frac{1}{8}$ to $\frac{1}{4}$ in. depending

upon the texture selected. Mortar for all coats is mixed in the proportions of 1 sack of portland cement to 3 cu.ft. of moist sand to which not more than 10 lb. of hydrated lime or lime putty can be added to give the mortar the required plasticity to spread readily. If color is desired in the finish coat it is obtained by adding the proper amount of a mineral oxide pigment of the required color. For light colored finishes use white portland cement.

Before applying the first or scratch coat the concrete masonry wall should be dampened to insure a good bond. The second coat is applied not sooner than 24 hours after the first coat. The first coat should be scratched to help provide better bond for the second coat which is also scratched to provide bond for the final coat. The final or finish coat should not be put on sooner than 7 days after the second coat. Plaster coats should be kept constantly moist for at least 2 days by sprinkling to aid in curing. A competent plasterer or stucco contractor should be employed to be assured of a quality job that will give permanent satisfaction.

A Few of the Many Attractive Stucco Textures Commonly Used.

Italian

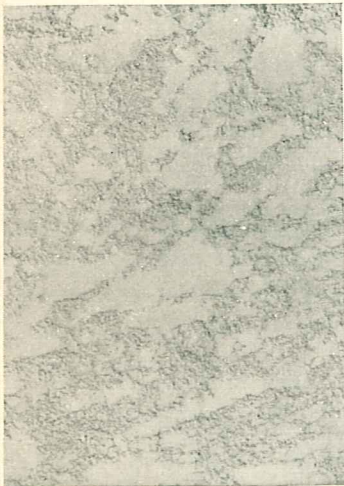

English Cottage



Spatterdash



Travertine





Benefits of running water are nowhere more needed and more appreciated than in the farm home.

WATER SUPPLY AND FARM SEWAGE DISPOSAL

The health of the family and the prosperity of the livestock enterprises on the farm depend upon a generous supply of safe drinking water. Family health protection is especially important. And if wells, springs and other sources of drinking water are not protected, the water may be-

come contaminated with disease germs from human, household and other wastes, thus transmitting such diseases as typhoid fever, diarrhea, dysentery and enteritis.

Fortunately, effective protection of the water supply is ordinarily neither difficult nor costly. Principal methods of protection are shown here. These methods are in accordance with suggestions made by state health departments and the U. S. Public Health Service*.

*Public Health Service Milk Ordinance and Code, 1939.

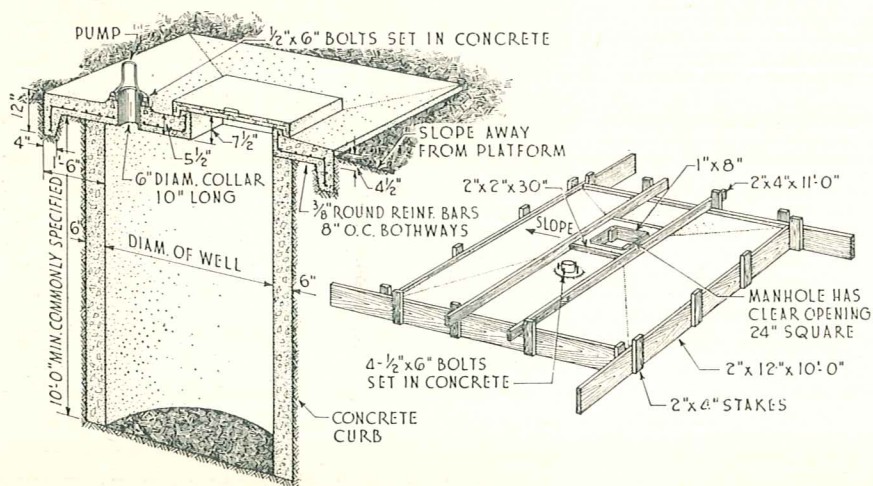
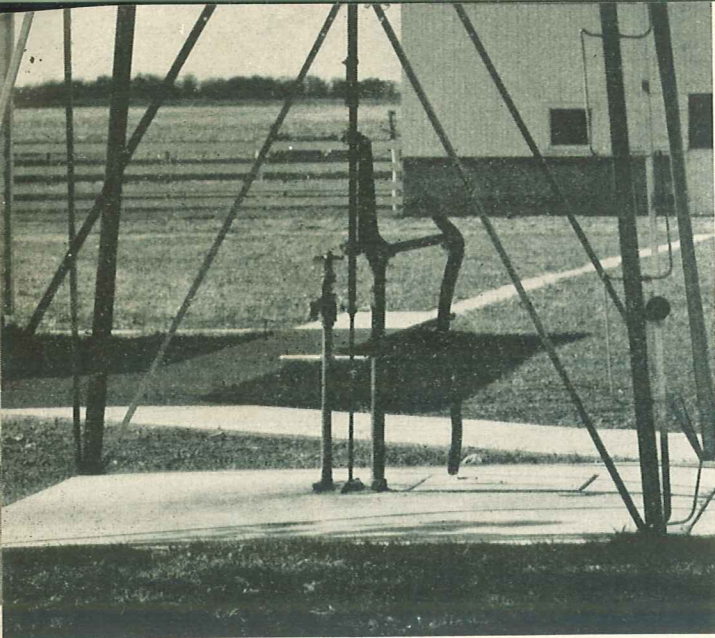

Fig. 15. Suggested method of protection for dug wells. The concrete platform may be precast as indicated or may be cast in place over the well.



the curved pieces, care being taken that the sheathing from points 1 to 2 is attached to pieces A; that sheathing from points 2 to 3 is attached to pieces B, and so on. Adjacent sections of the form are fastened together with $\frac{1}{2}$ "x4-in. bolts. The small wedge-shaped section of form built with pieces C is the last section to be anchored in position and the first to be taken out when forms are removed. Form faces should be well oiled to help make removal of the forms easy.

The concrete well platform may be built as shown in Fig. 15, and should extend a minimum

Concrete well platforms (above left and column 1, page 29) and spring curbs (below) provide excellent protection for the water supply.

How to Protect Wells and Springs

Excellent protection for *dug wells* is provided by a concrete well curb and platform as shown in Fig. 15. This construction effectively shuts out surface water, small animals and other sources of contamination. It is suggested that concrete be of the 1:2 $\frac{1}{4}$:3 mix. In building a concrete curb, the earth walls of the well are usually satisfactory for the outer forms. Inner forms may be made as shown in Fig. 16. This collapsible, reusable form is especially convenient. The curved form pieces should be cut accurately to the desired curve and proper lengths, depending upon the diameter of the well. Form sheathing consists of 1x4's nailed to



SHEATHING FROM POINT 1 TO 2 IS ATTACHED TO PIECE "A" FROM 2 TO 3 ATTACHED TO PIECE "B" ETC.

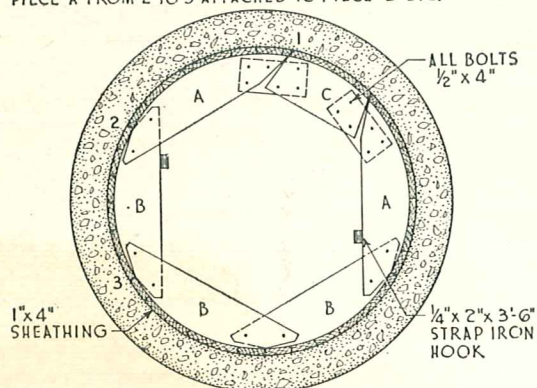

Fig. 16. Reusable inner forms for building the concrete well curb. The earth walls of the well ordinarily serve for outer forms.

of 1 ft. 6 in. out from the edges of the well. The platform may be precast on level ground near the well, then set in position after it has thoroughly hardened, or it may be cast in place over the well. In the latter case a tight, temporary board platform is built over the well to support the concrete until it has hardened. A manhole about 24 in. square is usually desirable. The manhole and cover are built as shown in Figs. 15 and 17 to secure a tight fit.

Drilled wells should be protected with a concrete platform of adequate size as shown in Fig. 18. Health authorities usually suggest that the platform be a minimum of 6 ft. square.

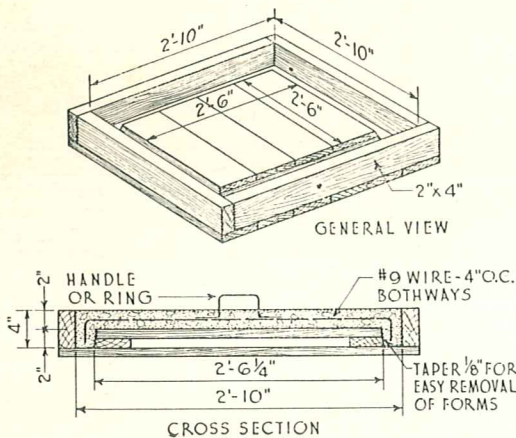

Fig. 17. Concrete manhole covers are built as shown here to secure a tight fit.

A cutoff wall or apron at least 1 ft. deep around the outside edge helps prevent undermining of the platform. It is especially important that the well casing extend up above the top of the platform about 3 in. as shown in the drawing. This prevents entrance into the casing of any contaminated storm water which may be driven under the pump housing.

Springs may be protected by building a concrete box or curb around the spring as shown in Fig. 19. A ditch is provided along the uphill side of the spring to keep surface water from draining into and possibly polluting the spring (see drawing). The manhole cover should be secured in place with chain and lock. An outlet tile drain and small concrete slab, as shown, promotes a sanitary condition around the outlet.

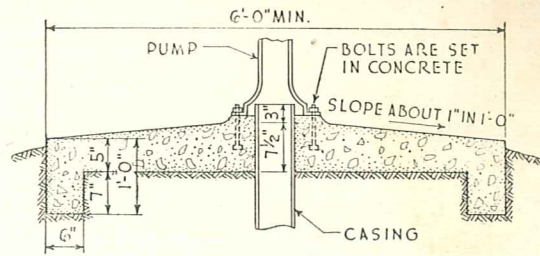

Fig. 18. Method of building concrete platform to protect drilled wells. The well casing should always extend up above the top of the platform as shown to prevent any contaminated storm water from being driven into the casing.

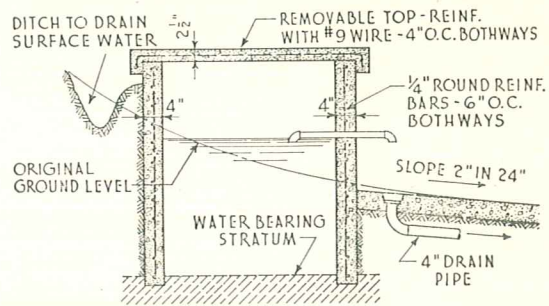

Fig. 19. Suggested method of protecting spring water supply.

Concrete Pump Pits

A pump pit is often required to provide proper protection for modern automatic pumps and water systems. Advantages of the concrete pit are that it protects the system from freezing during cold weather and keeps water cooler during the summer season. Suggested construction is shown in Fig. 20. It is important that the pit be provided with drainage and ventilation as indicated in the drawing. Pump pits for farm water systems are usually about 7 ft. square and 7 ft. deep but should always be built to fit the type of equipment installed. In the case of shallow well pumps it is common practice to place the small pneumatic storage tank entirely within the pit. The larger storage tanks often used with deep well installations may be placed so that only 10 or 12 in. of one end of the tank project into the pump pit. Drainage as indicated in Fig. 20 should be provided to prevent flooding of the pit.

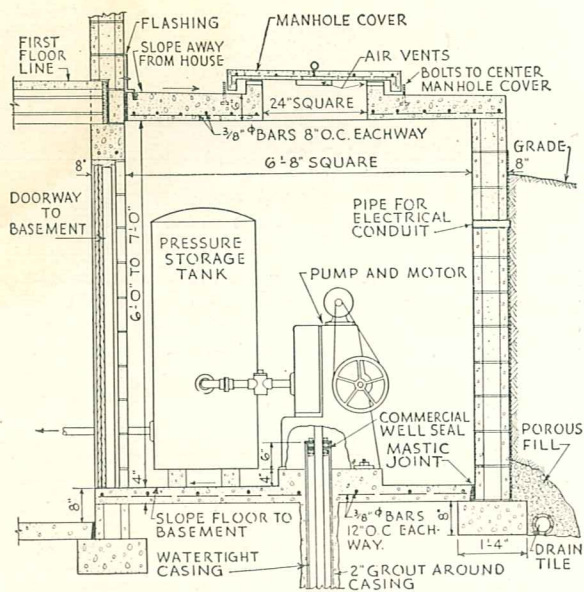

Fig. 20. An off-the-basement pump room with concrete block walls. The basement floor should be provided with a gravity drain to a surface outlet.

Water Requirements

A convenient time to check up on the total farm water requirement is at the time when improvements to the water supply are being planned. If running water is being provided for the first time, care should be taken that the well and pumping equipment have sufficient capacity. The amount of water consumed for household uses in particular is likely to be much greater than before running water was installed. Experience shows that after the family becomes accustomed to an ample supply of water, each member uses about 40 to 50 gal. per day. Thus, a family of 5 persons will, on the average, use a total of 200 to 250 gal. of water each day. This amount includes water for all household uses such as cooking, washing clothes, bathing, etc.

Average daily livestock consumption of water is as follows:

- Each milk cow 35 gal.
- Each steer or dry cow 12 gal.
- Each horse 12 gal.
- Each hog 4 gal.
- Each sheep 2 gal.
- Each 100 chickens 4 gal.

Concrete Cisterns

An ample supply of clean, soft water for the home is a convenience appreciated by every farm family. Plans for a family-size concrete cistern are shown in Fig. 21.

Suggestions here concerning construction and care of cisterns are intended principally for cisterns holding rain water supplies for household purposes other than drinking. The cistern shown, however, is equally suitable for storage of drinking water in areas where safe and ample supplies of well water can not be secured. A drilled well or a dug well, however, can be more securely protected against contamination than can a cistern. Wells should, therefore, be used for the drinking water supply whenever possible.

High quality concrete and first-class workmanship are essential in cistern construction to assure that the finished structure will be watertight. Watertight concrete is obtained with the 1:2¼:3 mix if other suggested practices in concrete making are followed (see pages 5 to 10). Proper reinforcement of the cistern is shown in the plans. Reinforcing bars should be placed as shown and securely wired together. Ends of bars should extend past each other 2 ft. at laps.

A filter to remove sediment from rain water is usually desirable. The filter can be built on top of the cistern as shown in the drawing or it can be built separately with a connection to carry the clean water to the cistern. The type of filter shown has proved practical and in every way satisfactory provided it is given occasional cleaning. Some debris, such as sticks, leaves, cinders, etc., will be carried into the filter with the rain water. This unwanted material must be removed

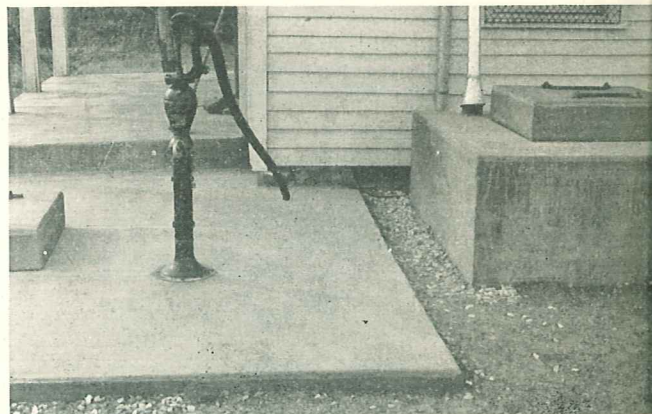

Concrete cistern of the type shown in construction details in Fig. 21 but with filter built separately from the cistern.

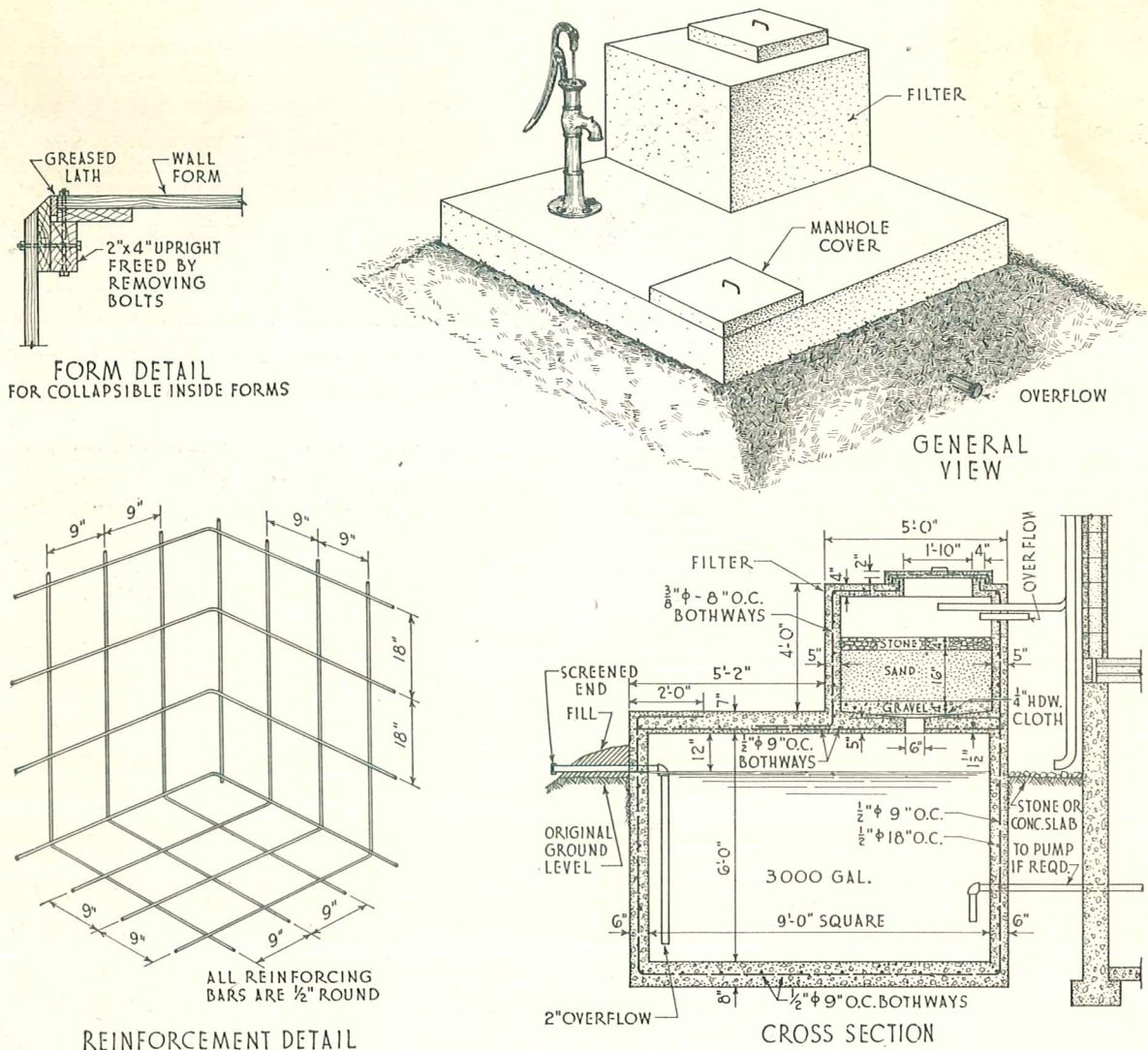

Fig. 21. Family-size concrete cistern with filter.

from the filter from time to time by removing the top layer of stones and sand and replacing with similar clean materials.

Cistern water should never be considered entirely safe for drinking unless it is first chemically sterilized or boiled. The first time water is placed in a new concrete cistern it may become quite hard. This hardening effect can be considerably reduced by letting the new concrete cure or harden thoroughly before the cistern is filled. If the first filling becomes undesirably hard despite this precaution, the water may be softened as follows: Dissolve 2 lb. of baking soda in 1 or 2 gal. of water, then thoroughly mix this solution into the cistern water.

Stock Watering Tanks

Concrete stock watering tanks properly built are watertight and concrete will not rot or rust. Suggested construction of a rectangular stock tank is shown in Fig. 22. As in the case of concrete cisterns, it is important to use high quality concrete and good workmanship in order to obtain a watertight tank.

Steps in construction are relatively simple. Reinforcing bars should be bent and wired securely in position as indicated in the plan. Outside and inside forms are built next, then the concrete floor of the tank is placed. Care should be taken to keep the reinforcement in position in the center of the floor as concrete is placed.

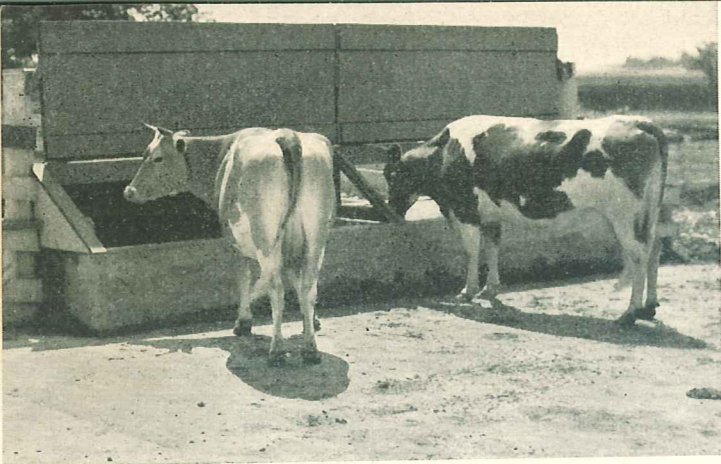

Rectangular stock watering tank of concrete. The pavement around the tank helps keep cattle clean.



Well built concrete tanks give trouble-free service for a lifetime.

Concreting should be continuous, walls of the tank being placed immediately following the floor. In this way the possibility of a leaky construction joint is avoided. Concrete should be spaded thoroughly next to the form faces to produce dense, smooth surfaces.

After concrete hardens for 2 or 3 days, forms may be removed. Any stony spots found are patched immediately with a cement-sand mortar consisting of 1 volume portland cement to 2½

volumes sand with just enough water to make a plastic mortar. The mortar should be worked into the rough spots with a wood float, then left to harden. After the mortar has become quite stiff, it may be troweled firmly but sparingly with a steel trowel to make a smooth, tight patch.

The new concrete tank should then be protected from drying out for at least 7 days by covering with burlap or other material and keeping it wet.

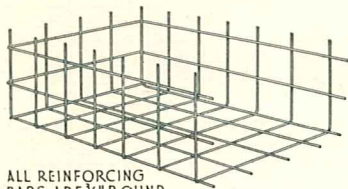

ALL REINFORCING BARS ARE 3/8" ROUND SPACED ABOUT 8" O.C. BOTHWAYS

REINFORCEMENT DETAIL

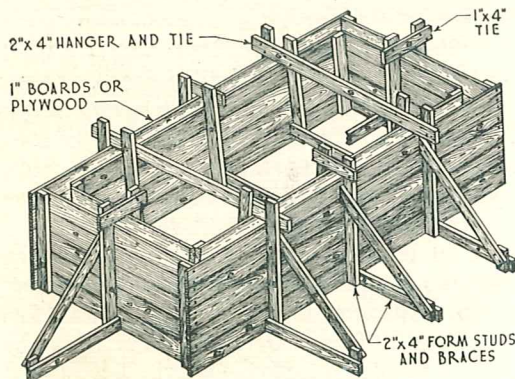

2"x4" HANGER AND TIE

1" BOARDS OR PLYWOOD

1"x4" TIE

2"x4" FORM STUDS AND BRACES

GENERAL VIEW OF FORMS

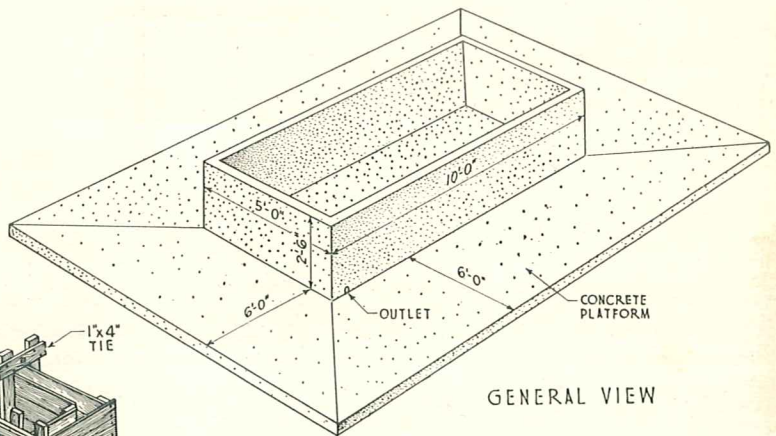

GENERAL VIEW

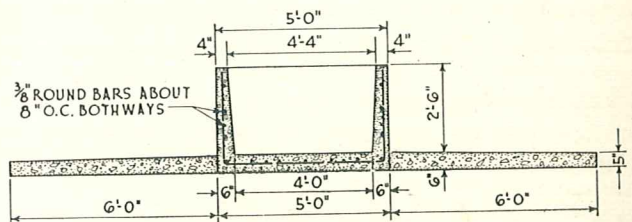

CROSS SECTION

Fig. 22. Plans for concrete stock watering tank.

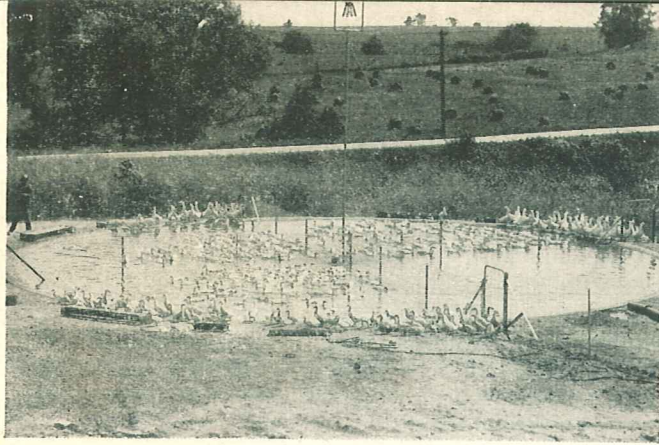

Ducks provided with their own pool at home do not wander away to encounter the dangers of the highway.

Experience shows that a pavement around the tank is highly desirable since it makes a clean, mud-free area. Construction of a pavement is similar to that of a feeding floor described under "Feeding Floors and Yard Pavements", page 14.

Reservoir for Storing Water for Fire Protection

Each year thousands of farm people lose their lives or are seriously injured in fires and millions of dollars worth of buildings, livestock, feed and equipment are destroyed. Much of this tragedy and damage could be reduced if an adequate supply of water were available. A storage tank should have a minimum capacity of 3,000 gal. to be reserved solely for fire fighting. This will usually be an adequate supply for most rural fire-fighting equipment.

It is generally recommended that the fire cistern be located within 700 ft. of the building group but not closer than 50 ft. to the house, barn or other major building.

Typical plans for a 3,000-gal. tank as shown in Fig. 9 can be had free in the United States and Canada by requesting the booklet, *Concrete Fire Cistern*, from the Portland Cement Association.

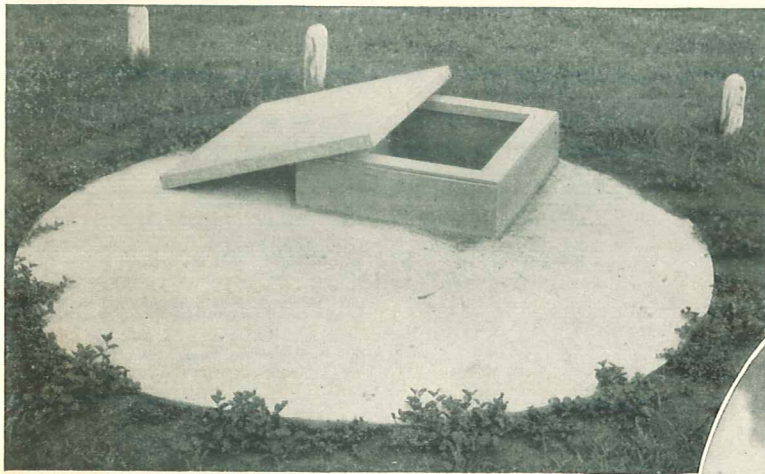

A typical fire cistern. A heavy concrete manhole cover should be used to prevent uncovering by small children. A concrete water tank holding 3,000 to 4,000 gal. of water for fire protection can help prevent serious fire losses.

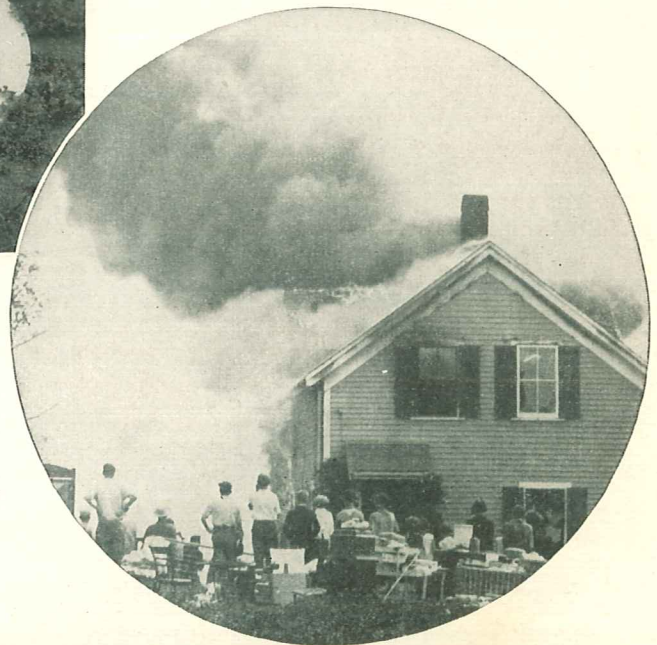

Farm Sewage Disposal System

A sewage disposal system is usually one of the first improvements built when running water is installed in the farm home. Fig. 24 illustrates the layout of a typical farm sewage disposal system. Principal parts of the system are the septic tank and the tile lines through which final disposal is made of the liquids discharged from the tank.

The purpose of the system is to provide safe and inoffensive disposal of sewage from the home and to help protect the water supply against pollution. Much of the solid matter entering the septic tank with the sewage is broken up into gases, liquids and mineral parts through bacterial action. In a well built system the gases pass off readily without offense, liquids flow out of the

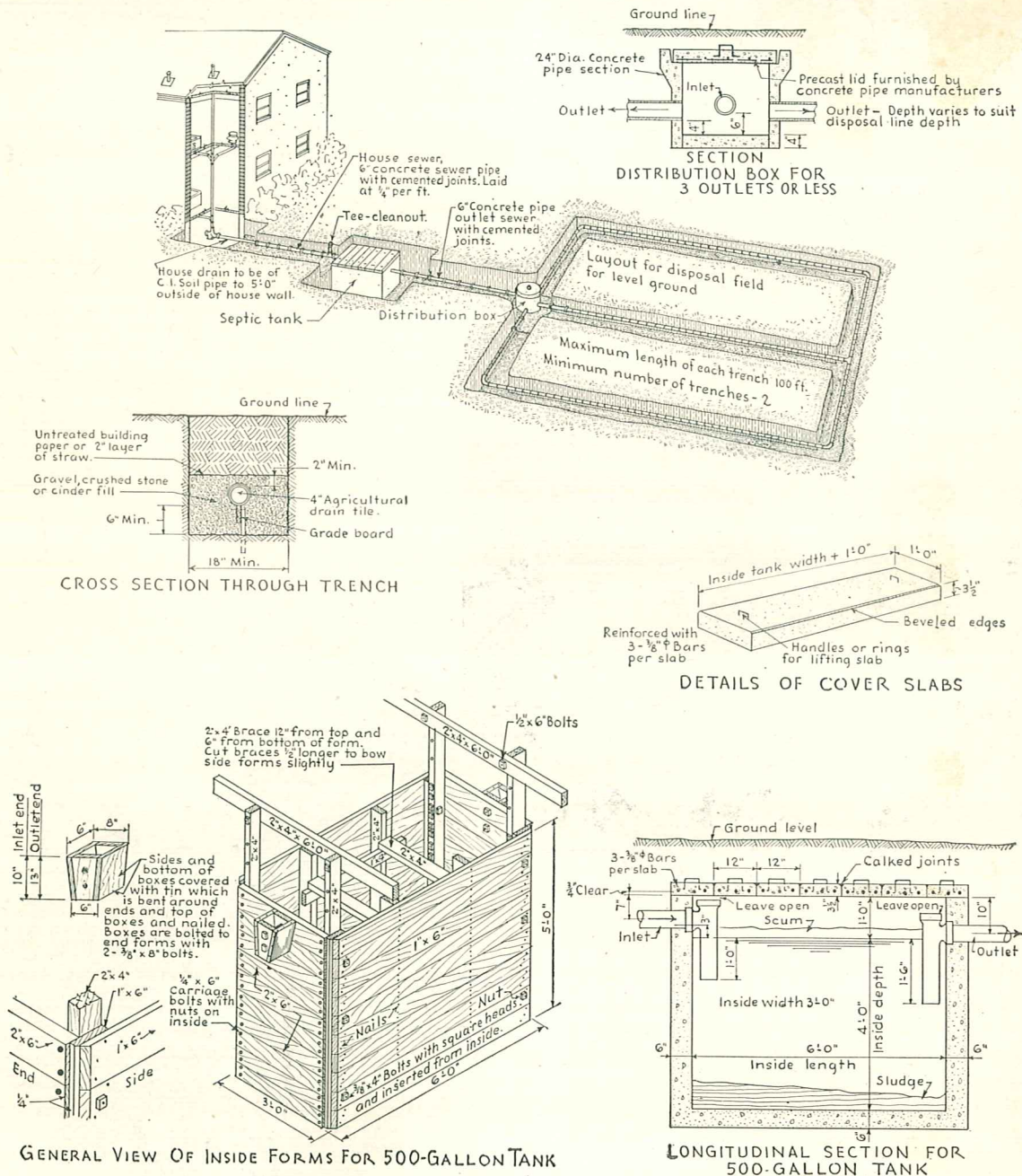

Fig. 24. Typical layout and suggested construction of a farm sewage disposal system. Sewer pipe Y's should be used in the tank in place of T's shown if reusable forms of 2-in. plank are employed.

septic tank into the tile lines, and the heavier solids, called sludge, settle to the bottom. A scum which forms over the top of the sewage in the tank aids in decomposition.

To operate effectively, sewage must be retained in the septic tank from 24 to 60 hours. It is thus important to build a tank of adequate capacity. The family-size tank shown here is the smallest practical size to build, even though the family consists of only 2 or 3 persons.

Septic Tank Location and Construction.

The septic tank should always be located at least 100 ft. away from the well or other water supply. The sewer line from the house to the septic tank should be a 4-in. or larger size sewer pipe laid with tightly cemented joints. A slope of at least 1 in. in 5 ft. should be given the house sewer line and it should be as straight as possible to minimize danger of clogging.

The 1:2¼:3 concrete mix is suggested for septic tanks. Care should be taken to secure a workable mix and the concrete should be spaded along form faces to help secure dense, water-tight concrete. The sewer pipe T's which form the submerged inlet and outlet of the septic tank are cast in place in the wall. The following con-



Precast concrete septic tanks are available in some localities. Here is one being delivered and installed. Family-size precast tanks should have a minimum working capacity of 500 gal. and should provide for a sewage depth of at least 4 ft.

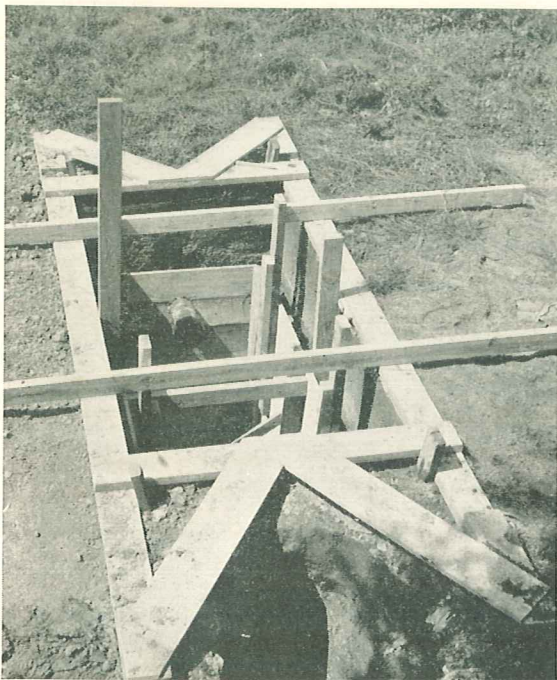

Forms in place for concrete septic tank walls. Note use of planks around edge of excavation to prevent caving of earth walls which serve as outside forms.

crete materials are needed for the family-size septic tank:

- 2 cu.yd. sand
- 2¼ cu.yd. gravel
- 17 sacks portland cement
- 21 pieces ¾-in. round reinforcing bars, 4 ft. long

Precast cover slabs about 3½ in. thick, 1 ft. wide and 4 ft. long are used for the top of the tank. Each slab is reinforced by placing three ¾-in. round reinforcing bars near the bottom of the slab. For convenience in removing the slabs from the tank, reinforcing bars may be bent and set in the fresh concrete to provide handles, or old horseshoes may be used for this purpose.

Tile Lines. A tight sewer line conducts the discharge from the tank to the tile lines for final disposal by subsurface irrigation. No part of the open tile field should be within 200 ft. of the farm water supply. The length of tile lines

needed to dispose of the septic tank liquids depends upon the kind of soil and the amount of sewage. In loose soils where the ground water level is several feet below the surface, 30 ft. of drain tile for each person in the family is usually satisfactory. In tight soils as much as 100 ft. of drain tile per person may be required. The lines of drain tile should be located about 10 ft. apart and should slope about 1 in. in 25 ft. Tile of 4-in. diameter are usually employed laid with openings of about $\frac{1}{8}$ in. between tiles. In tight soils it is best practice to place 8 or 10 in. of crushed rock, loose gravel or cinders over and around each tile line to speed absorption of the sewage liquids. In sandy soils joints between tile should be covered with small strips of tar paper to prevent fine particles from sifting into the tile lines. The tile line should be laid about 15 in. below the surface, never with more than 18 in. of cover.

Even in northern states and in Canada where severely cold winter weather is experienced, the tile lines should not be deeper than 18 in. since

the bacteria which act on the sewage to render it harmless are present in sufficient numbers only in the top layer of soil. Neither the septic tank nor the tile lines ordinarily give trouble even in coldest winter weather, providing the system is well built and in constant use. A system which lies idle over the winter will, however, often be seriously damaged by freezing. Where the tile lines are in a severely exposed location, it is common to provide a protective covering of about 1 ft. of hay or straw during the winter.

Care of the Septic Tank. The septic tank requires very little attention if the sewage disposal system is well built. It is best practice, however, to examine the tank once in every 3 to 5 years, removing accumulated sludge so that tile lines will not become clogged. Sludge removed may contain dangerous disease germs and it should, therefore, be buried immediately. It has no significant fertilizing value. Never use disinfectants in the septic tank because such materials destroy bacterial life which is the chief agent in decomposing the sewage.

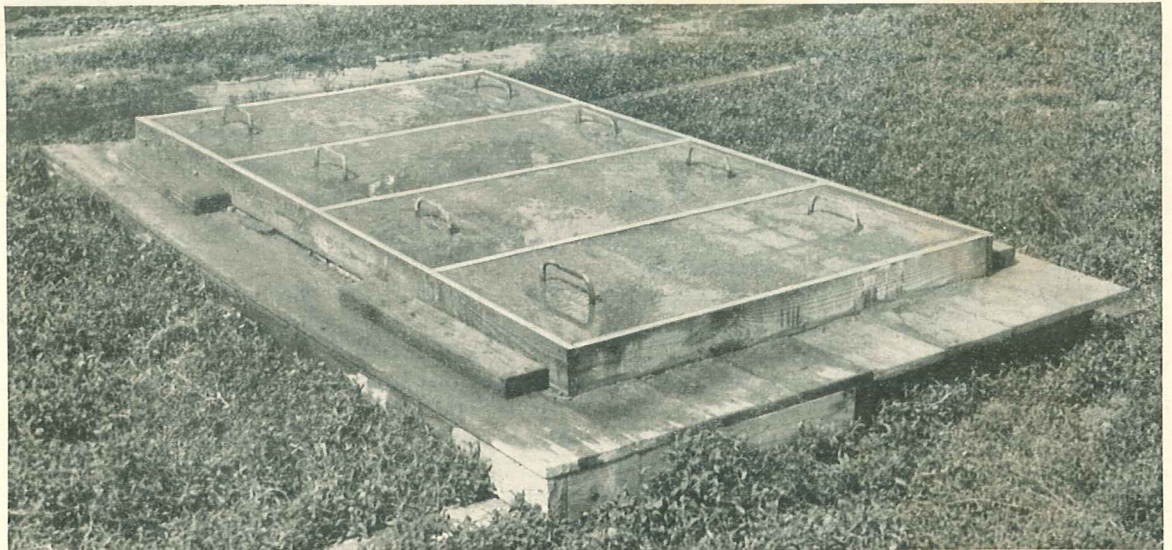

Concrete cover slabs for the septic tank are precast in this manner using 2x4's for form pieces. For ease in handling, however, slabs are often made only 12 in. wide as shown in Fig. 24.



Well built concrete steps help provide an attractive entrance for the home.

IMPROVEMENTS AROUND THE HOME

Concrete Steps

One of the most satisfying repair or remodeling jobs on the farm is the building of safe, permanent concrete steps. Concrete steps are safe because they are not slippery in wet weather, they do not rot and they are proof against termite

attack. Safest and easiest steps to climb have a tread 10 to 11 in. wide and a step height or rise of 7 to 8 in. between treads.

Forms for concrete steps may be built as shown in Fig. 25. Side forms are usually 1-in. boards backed-up with 2x4 form studs braced

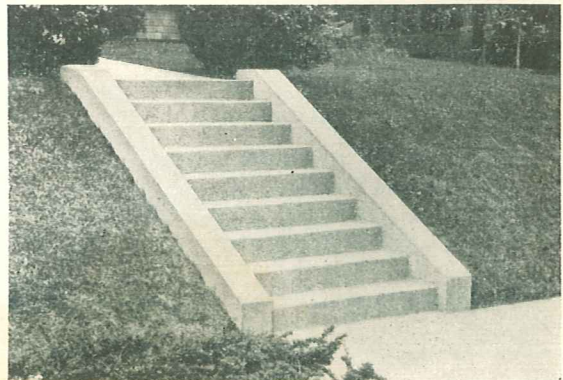
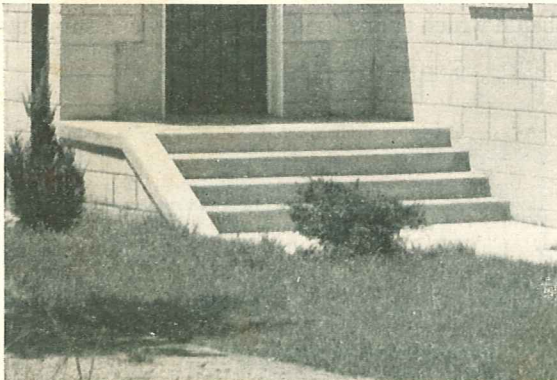

Left—Wide concrete steps and stoop make a safe, permanent approach. *Right*—Concrete steps for a terrace or other steep slope are commonly built with side walls in this manner. This concrete was treated to produce an attractive, granite-like finish.

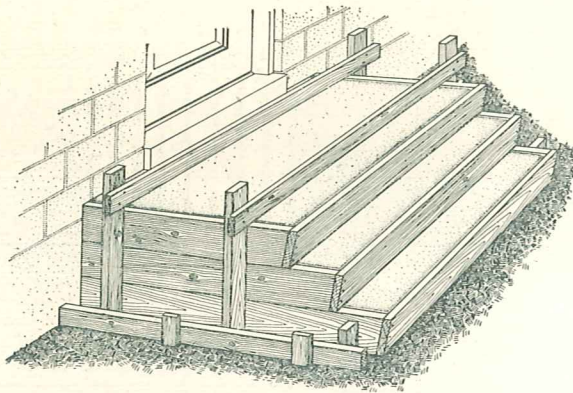

Fig. 25. Method of building forms for concrete steps. Note that riser form boards are tilted in at the bottom about 1 in. to provide additional toe space on the treads (see text).

and tied as shown. Riser forms for steps not more than about 3 ft. wide may be of 1x8 boards; wider steps require 2x8 riser forms to prevent bending or bulging when the forms are filled with concrete. Where 1x8 or 2x8 riser forms are used, an actual step height or rise of about $7\frac{1}{2}$ in. is obtained, resulting in steps which are easy to climb. If one low riser is needed to complete a set of steps the low step, for the sake of safety, should always be the bottom step. To make steps which afford maximum comfort in climbing, the riser form boards may be tilted in at the bottom about 1 in. as shown in the drawing. This provides additional toe space on the treads. Edges of steps are rounded by finishing with an edging tool after concrete has become quite stiff.

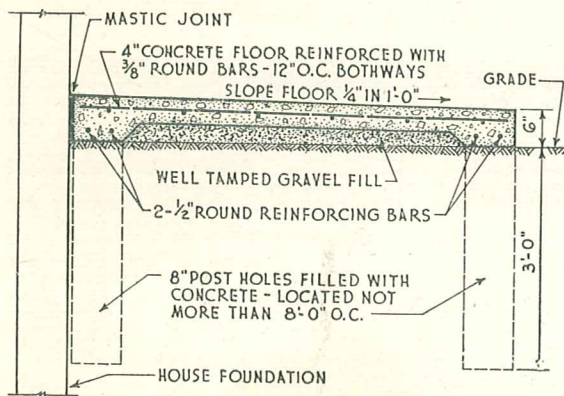

Fig. 26. Suggested construction for concrete porch floors built on shallow fill. The floor slab is supported on concrete piers made by filling 8-in. post holes with concrete.



A concrete porch of generous size provides a desirable outdoor living room for enjoyment in good weather.

Concrete Porch Floors

Where the new concrete porch floor is to be 2 ft. or less above the general ground level, a simple slab built on a fill, as shown in Fig. 26, makes an excellent floor. The fill of gravel, crushed rock or cinders which supports the floor should be well tamped before placing concrete. The concrete floor is usually built 4 to 5 in. thick and should be reinforced as shown as a protection against possible cracking due to uneven settlement. It is also important that the thickened edges of the concrete slab be reinforced with two $\frac{1}{2}$ -in. round reinforcing bars as shown. This construction makes a reinforced concrete beam which spans the distance between support-

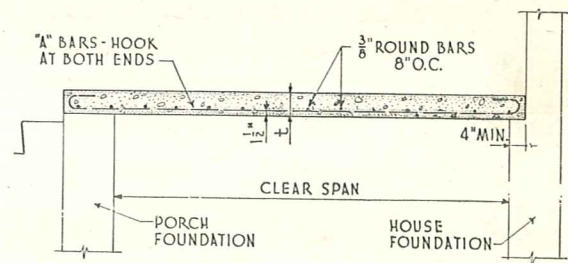
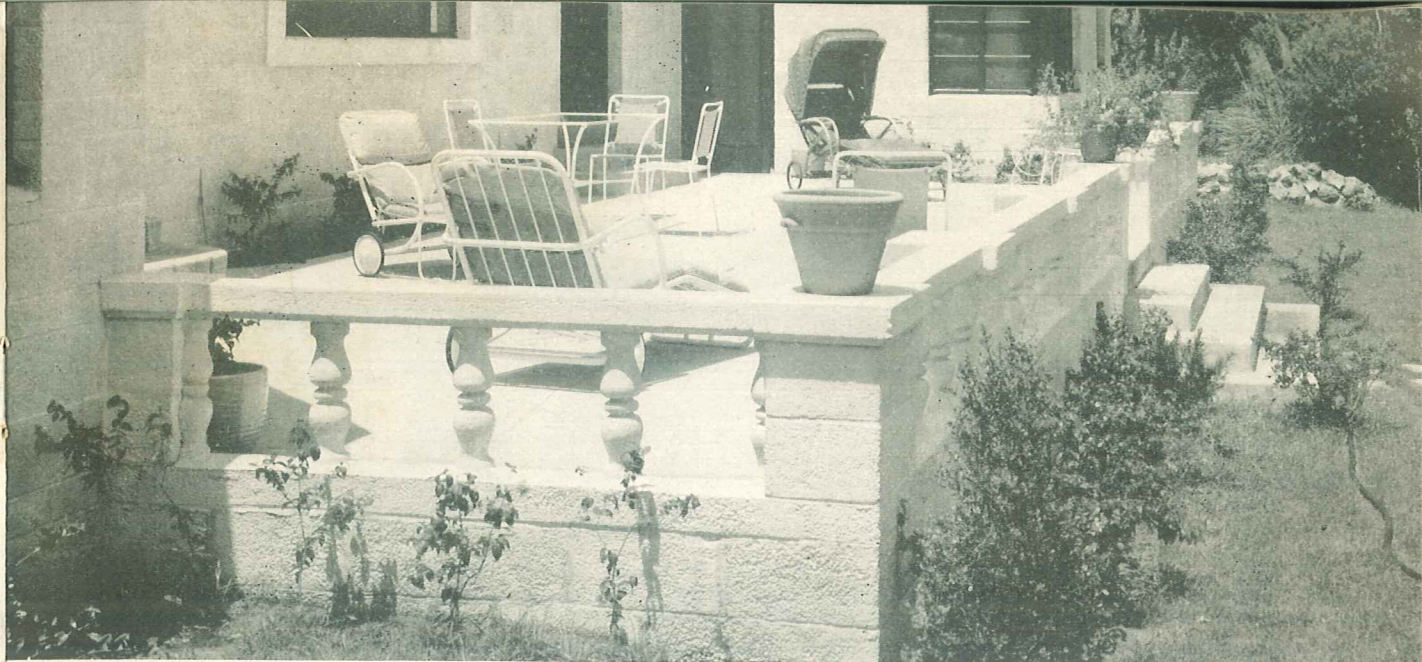

Fig. 27. Concrete porch floors supported on continuous foundation walls may be built as shown here. Proper reinforcement for the concrete slab is given in Table VIII.



This concrete masonry porch has been brightened by painting with white portland cement paint.

ing piers. The piers are made by filling 8-in. post holes with concrete. At laps the ends of $\frac{1}{2}$ -in. round bars should extend past each other about 2 ft. The porch floor should be sloped about $\frac{1}{4}$ in. in 1 ft. to provide good drainage.

Where the porch floor is 2 ft. or more above the ground level, it should be made of reinforced concrete supported on continuous foundation walls as shown in Fig. 27. Required thickness of the concrete slab and proper reinforcement are shown in Table VIII.

TABLE VIII—Dimensions and Reinforcement of Reinforced Concrete Porch Floor*
For design shown in Fig. 27

Clear span in feet	Thickness of slab in inches <i>l</i>	Size and spacing of "A" bars required in slab
4	5	$\frac{3}{8}$ -in. round reinforcing bars 7 $\frac{1}{2}$ in. o. c.
6	5	$\frac{3}{8}$ -in. round reinforcing bars 6 in. o. c.
8	5 $\frac{1}{2}$	$\frac{1}{2}$ -in. round reinforcing bars 9 $\frac{1}{2}$ in. o. c.
10	6	$\frac{1}{2}$ -in. round reinforcing bars 8 in. o. c.

*All transverse reinforcing bars are $\frac{3}{8}$ -in. round bars placed 8 in. on centers.

Concrete Flagstones

Concrete flagstones or stepping stones do much to improve the appearance of the home grounds, at the same time making convenient, mud-free foot paths around the home. Forms for casting the small concrete slabs are shown in Fig. 28. It is intended that the type of form shown will be taken apart after the flagstones harden for 2 or 3 days. The precast flagstones may then be used to make a walk of desired pattern.

With forms made from 1x3 strips the concrete slabs will be about $2\frac{5}{8}$ in. thick. It is thus suggested that the 1:2 $\frac{1}{4}$:2 $\frac{1}{2}$ concrete mix be used with $\frac{3}{4}$ -in. maximum size gravel, and with not more than 5 gal. of water added per sack of

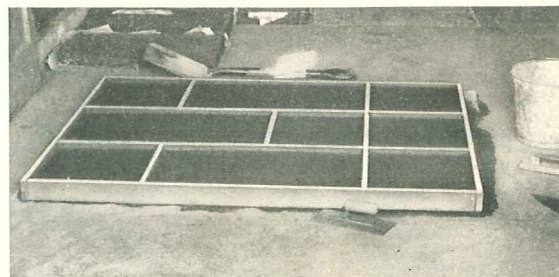

Building concrete flagstones is an interesting job which provides lasting improvements around the home. These slabs were given a red colored topping.

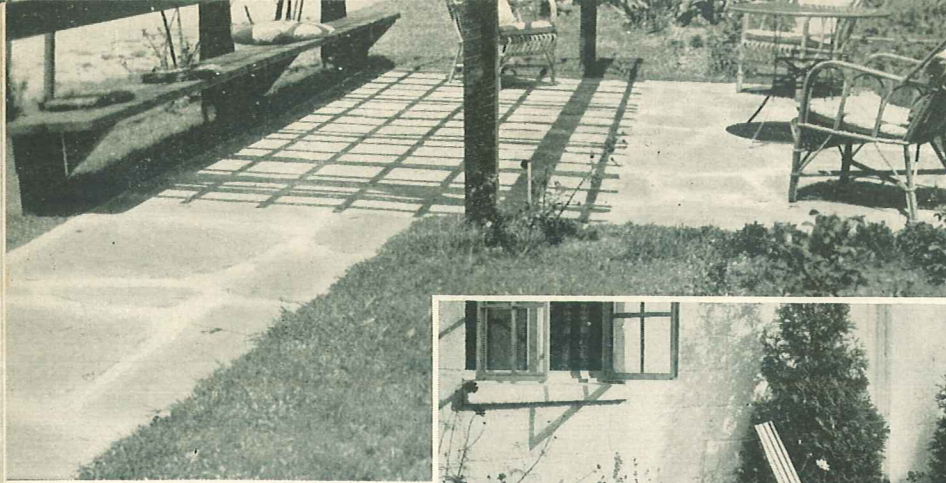

Walks and paved areas may be made of concrete flagstones set in portland cement mortar as at the left, or spaced as shown at the right with grass growing between the slabs.

portland cement with average moist sand. The concrete flagstones may be cast on any smooth surface. If desired, several thicknesses of paper may be placed on the floor or other surface to make slab removal easier and to help keep the surface clean.

A walk or other paved area can sometimes be built more rapidly by a slightly different method. This alternate method is as follows: Forms are made of 2-in. material shaped as shown in the alternate detail in Fig. 28, nailed securely, then employed as a unit, raising the forms immediately after concrete has been troweled. Screen door handles are attached to the top of form end pieces so that the forms may be raised straight up as a unit without disturbing the freshly

placed concrete. With this method a rather stiff concrete mix must be employed. As soon as the form is removed it is cleaned, re-oiled, then set in the next position and again filled with concrete. With a well proportioned concrete mix, this is perhaps the most rapid method of building a flagstone walk. Units which are damaged slightly in removing forms can be patched readily using two trowels and some stiff mortar to form new edges.

Colored flagstones can be produced with mineral pigments mixed in the concrete or in the top mortar as a surface treatment. Instructions on how to make colored concrete may be had by requesting Concrete Information sheet, *Colored Concrete Pavements and Walks* (free in U. S. and Canada).

Fig. 28. Method of casting concrete flagstones.

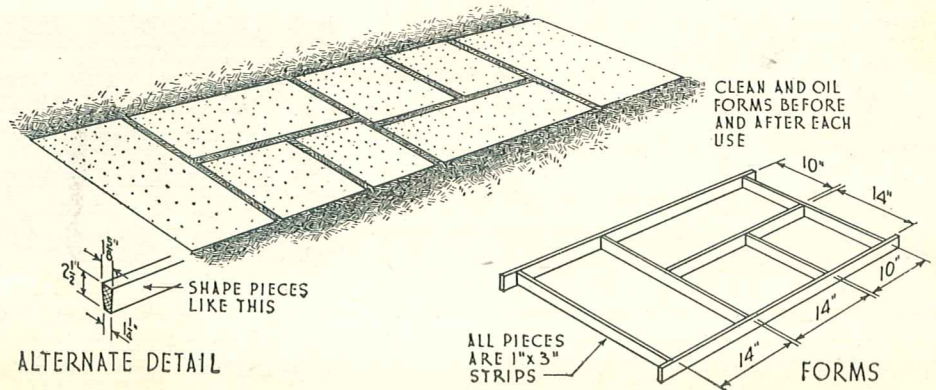

Lawn Furniture

Concrete lawn benches beautify the yard and help make a pleasant place to enjoy the outdoors during fine weather. Construction details for a lawn bench of simple yet graceful lines are given in Fig. 29. The seat is cast bottom side up on a form made of smooth boards or plywood so that the finished concrete will be smooth and level. Side and end forms are of 1x3 boards. Inside edges of the forms at the top are lined with carpet strip or quarter-round molding; bottom edges with cove molding as shown. The form for the seat supports is built of 1x4 boards, thus making the supports about $3\frac{5}{8}$ in. thick. Sheet metal strips are curved as shown and secured in place by tacking to the wood blocks. Forms intended for a large number of reuses should be coated with clean oil before and after each use.

As indicated in Table I, the proper concrete mix for this type of work is the 1:2 $\frac{1}{4}$:2 $\frac{1}{2}$ mix with $\frac{3}{4}$ -in. maximum size gravel. In building the seat, concrete of a workable mix is placed in the forms to a depth of about 2 in., then reinforcing bars are placed. Reinforcement should consist of $\frac{1}{4}$ -in. round bars, long bars being placed 6 in. apart, short bars 12 in. apart. After the balance of the concrete is placed and tamped, the surface is leveled with a strikeboard, then four $\frac{1}{2}$ x3-in. machine bolts are set at the required spacings. A wood float is used to work

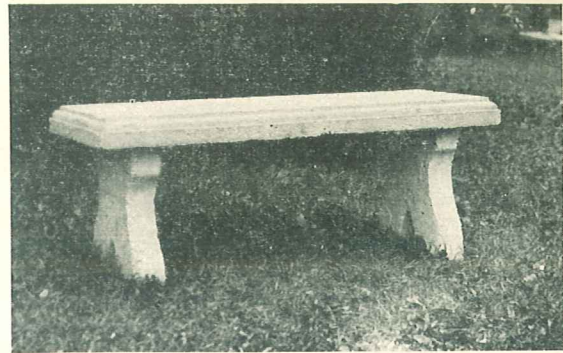

Permanent concrete benches help beautify the lawn and are relatively easy to build. Boys sometimes find a profitable venture in making concrete benches and other lawn furniture for sale.

the concrete into all corners of the forms and to produce an even surface. A trowel should be worked along form faces to prevent stony spots.

The seat supports are made in much the same way as the seat slab. In finishing the top surface of the supports, however, the steel finishing trowel may be used sparingly, after wood floating, to make a smooth dense surface. The concrete should be left to harden at least 2 days before forms are removed, a longer time in cool weather. The new concrete should be kept moist, that is cured, for at least 10 days. The bench may be erected after concrete has hardened for 2 weeks. If desired, the bolt holes in the seat

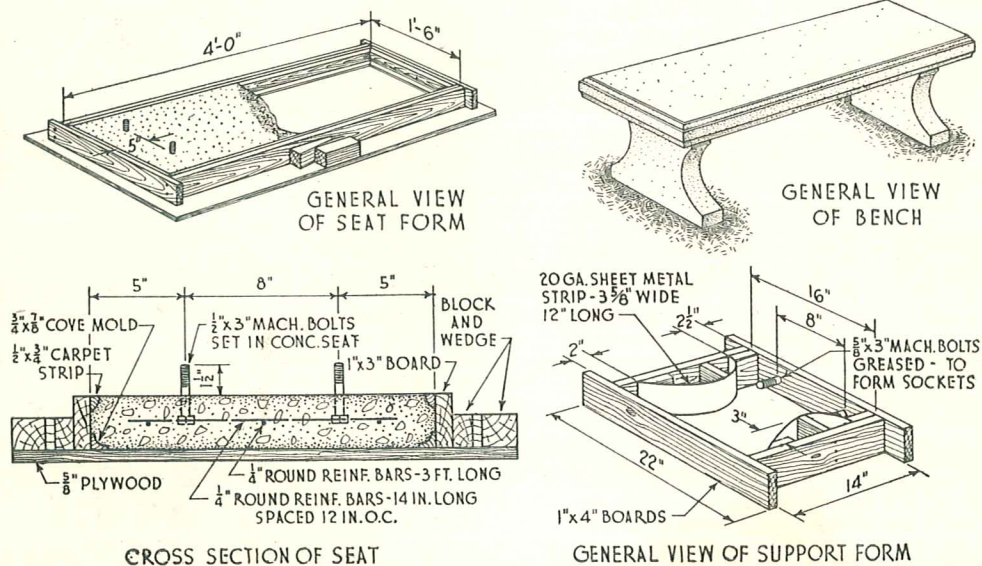
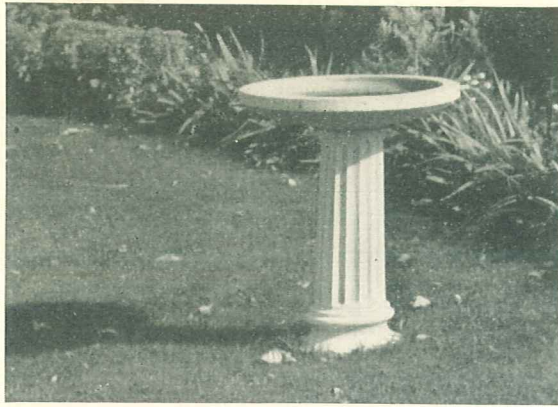

Fig. 29. Suggested details for a concrete lawn bench which is easy to build yet has graceful lines.



A concrete bird bath helps attract birds and makes an interesting improvement for the lawn.

supports may be filled with portland cement mortar so that the bolts will anchor the seat permanently to the supports.

To make sure that the bench will not settle into the lawn, a small concrete footing slab under each seat support may be provided. Footings 8 or 10 in. wide, 20 in. long and 5 or 6 in. deep are satisfactory.

A concrete bird bath decorates the lawn and helps bring and keep delightful songbirds around the home. Plans for a bird bath and pedestal which have pleasing lines are given in Fig. 30. The bird bath shown is relatively easy to build and makes an interesting subject for boys who like to construct lasting improvements for the home.

The bird bath is built in three separate parts: the footing slab or base, the pedestal and the bowl. Boards for the pedestal form are shaped to

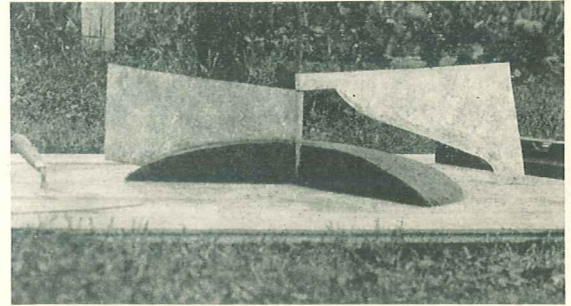

Bowl of bird bath may be formed on a clay core. Clay is cut away to show shape. The metal templates help in obtaining shape of bowl desired.

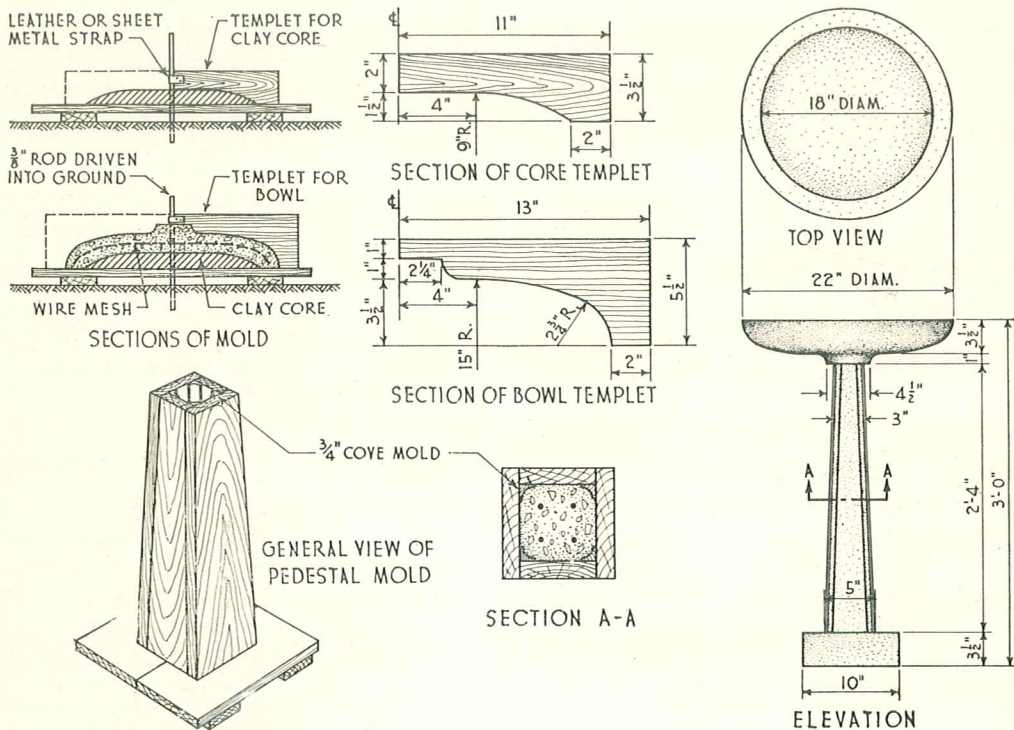
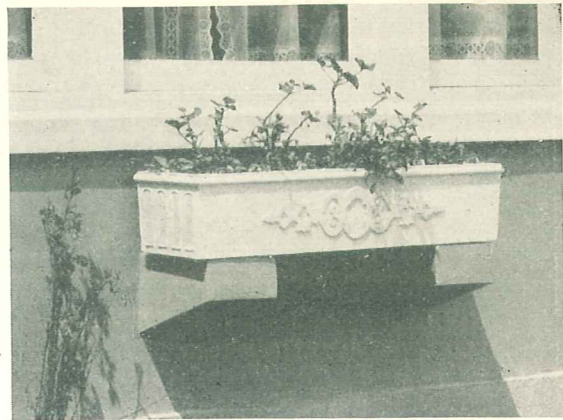

Fig. 30. Forms and suggested construction details for a concrete bird bath.

the desired taper, then corners of the form are lined with cove molding. Concrete should be spaded thoroughly as it is being placed to assure smooth surfaces and to fill all corners of the mold. A lath sharpened to a chisel point makes a satisfactory spade for small concrete work. A $\frac{5}{8}$ -in. greased bolt or dowel is centered in the top and set 3 in. deep in the fresh concrete, then removed after concrete hardens to form a hole so that the bowl can later be anchored to the pedestal.

The bowl of the bird bath is cast bottom side up, formed on a clay core or on an old disc from a disc harrow or similar convex surface. If a clay core is used a templet may be made as shown in Fig. 30 to help form the desired shape. Using a rather stiff mix about 1 in. of concrete is placed on the core then the wire mesh reinforcement is set followed by a final layer of concrete about 1 in. thick. The $1:1\frac{3}{4}:2\frac{1}{4}$ concrete mix is suggested. The concrete is shaped using a templet. After the bowl is shaped a $\frac{1}{2} \times 3$ -in. bolt is set in the exact center, projecting 2 in. After concrete hardens for 2 weeks the bird bath may be assembled, joining parts together with portland cement mortar.



An attractive, well built concrete flower box lasts indefinitely.

Flower Pots and Boxes. Fig. 31 shows a suggested method of building an attractive concrete window box for flowers. Reducing the length of the forms, a square concrete flower pot may also be made in a similar manner. Forms should be treated as described under "Concrete Lawn Benches", page 41.

Variations in ornamenting the box may be created by attaching decorative strips and panels to the forms in different patterns. A $\frac{3}{8} \times 1\frac{1}{16}$ -in. screen molding or $\frac{1}{2}$ -in. triangular-shaped strips are well suited for making decorative fluting. An edging tool may be used to produce smooth, curved top edges on the box. When completed the exterior may be painted with white or colored portland cement paint if desired.



This concrete flower urn is mounted on a pedestal or standard of concrete masonry and set into a low wall, thus helping to set off the yard to advantage.

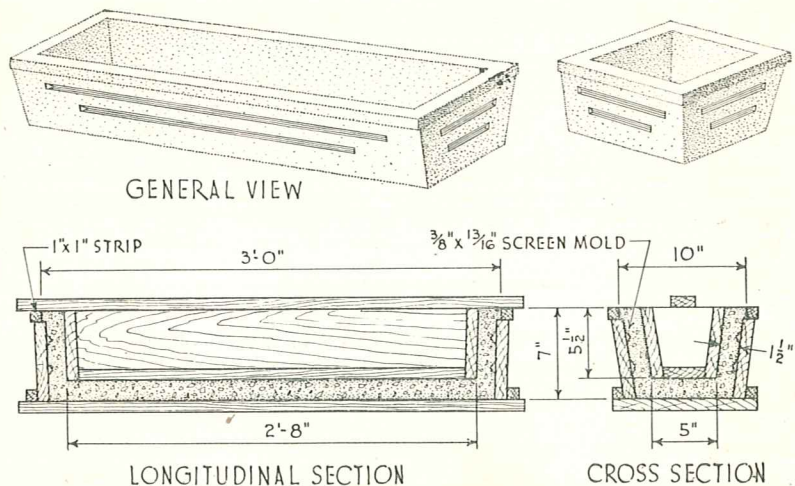

Fig. 31. Concrete flower pots and boxes may be formed as shown here.



Right—A rectangular lily pool is not difficult to build and it makes an exceptionally attractive improvement for the lawn or garden. *Left*—The lily pool may be made bowl-shaped in cross section if desired. Many people like to keep fish in the lily pool in addition to aquatic plants and flowers.

Lily Pools

Design details of an attractive lily pool are shown in Fig. 32. Steps in construction are as follows: The excavation is dug carefully to the dimensions selected so that, if possible, the earth walls will serve for outside forms. If the earth walls of the excavation do not stand well enough to act as outside forms, it is necessary to enlarge the excavation and build outside forms similar to those shown in Fig. 22. Reinforcing bars and supply and overflow pipes should be in position before concrete is placed. The 1:2¼:3 concrete mix is suggested. The concrete floor and walls of the tank are placed in a continuous operation so that possibilities of leaky construction joints are avoided.

Concrete lily pools are sometimes made bowl-shaped, thus requiring no forms. See alternate type of construction in drawings. In this case the earth excavation is made with carefully sloped sides to produce the shape and size of pool desired. Proper reinforcement and required piping are set next, then a thickness of about 6 in. of concrete is placed over the entire area. A pool of this kind is usually made about 3 ft. deep at the center.

A lily pool requires little attention or care but in winter in northern climates a covering of boards and straw is usually installed to protect the pool from severe freezing.

Where fish are to be kept in the new pool, water should be tested to find out whether it will support fish life. The following simple test is satisfactory: Pink litmus paper is placed in the water and if it turns blue the water is too alkaline to be safe for fish. The alkaline condition may be remedied by changing the water at weekly intervals until, in testing, the pink litmus paper remains pink when placed in the water.

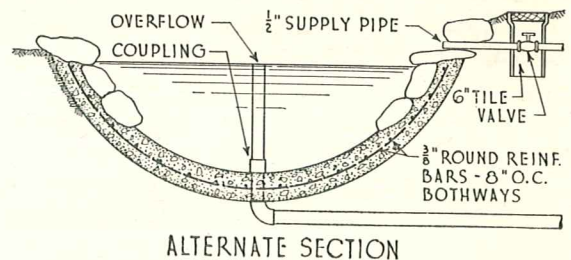
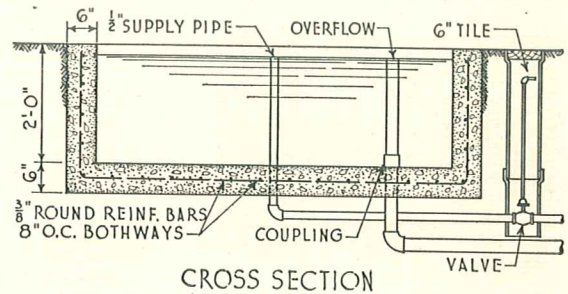
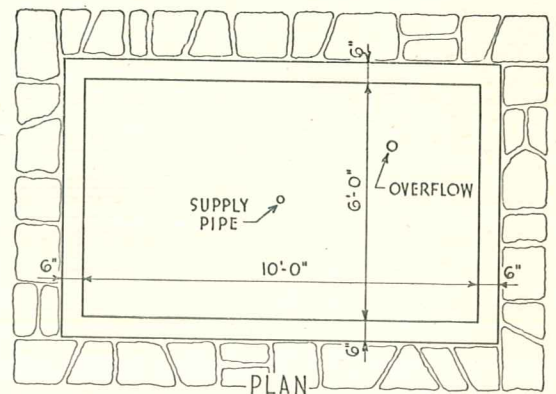
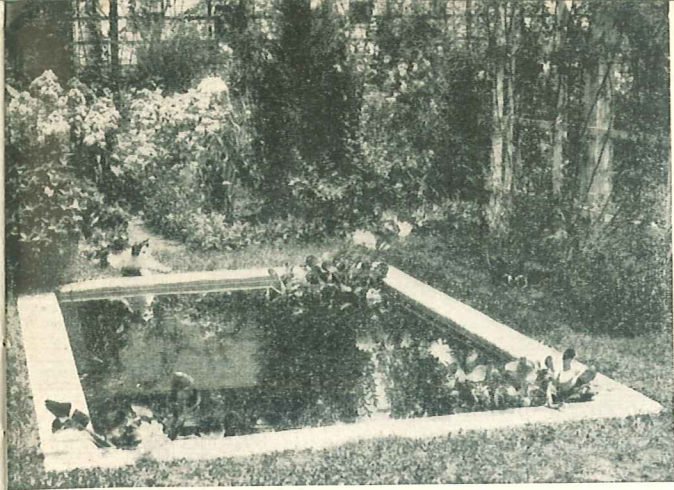

Fig. 32. Suggested plans for an easy-to-build rectangular lily pool or garden pool with alternate detail for bowl-shaped construction.



Tree Surgery

A tree cavity, unless repaired, tends to increase in size until it eventually kills the tree. For this reason cavities in fine shade trees should be permanently repaired by concreting, as shown.

Construction is relatively simple. Decayed parts are cut out leaving smooth, rounded edges. The interior of the cavity is then coated with creosote, crude petroleum or given some other treatment which prevents fungus growth. Coatings should not be allowed to come in contact with the cambium or growing layer just under the bark.

Shallow cavities are then filled as follows, using a mortar consisting of 1 part portland cement to 3 parts sand with only enough water

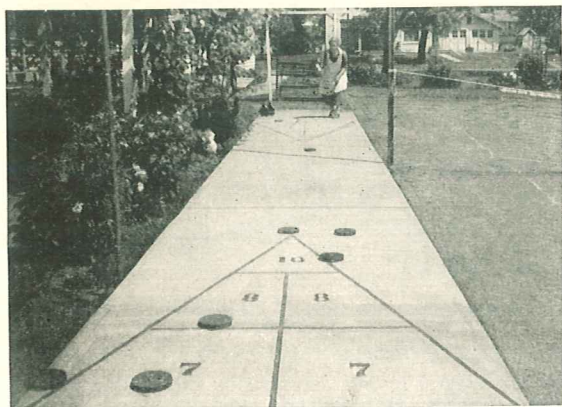

Shuffleboard, a long-time favorite deck sport on boats, is becoming increasingly popular as a lawn game. It is played on a smooth concrete court about 6 ft. wide and 50 ft. long marked as shown. For information on how to build the court, rules of the game, etc., send for Concrete Information sheet, *Shuffleboard—A Deck Sport Comes Ashore*, free in U. S. and Canada. Also available on request are instructions for construction of tennis, handball, badminton and other play courts.

added to produce a very stiff mix. Mortar should be so stiff that it can be formed into a ball when squeezed. In filling the cavity a board is held up against the lower 6 in. of the opening with one hand while the space is packed full of cement mortar with the other hand. The top surface of this 6-in. section of cement mortar is now leveled even with the top of the board form, then a tar paper divider is cut about $\frac{1}{2}$ in. shallower than the opening and laid over the mortar. The form board is then raised and the second section is filled and tamped and so on. As concreting progresses the face of the patch below the form is troweled to give it a smooth surface. If a rounded concrete surface is desired, a piece of heavy sheet metal may be used for a form in place of the board.

Deep cavities may be backfilled to within about 6 in. of the front of the opening with a very stiff concrete mix, 1 part portland cement to 5 parts sand or clean bank-run gravel. A piece of tar paper is then tacked against the face of this backfill and closing of the cavity is completed with the 1:3 cement-sand mortar as described above. The new concrete should be kept moist for about 10 days for proper curing. Bark and sapwood eventually grow over the edges of the patch, preserving the tree.



Cavities in fine shade trees are permanently repaired and the tree saved by proper concreting.

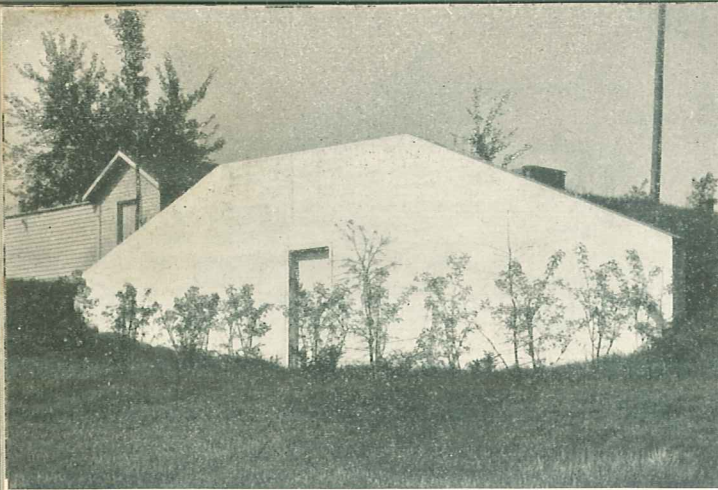

Home-grown fruit and vegetables can be kept in good condition for a considerable period of time when stored in an underground concrete storage cellar or cave.

Small Storage Cellar

A small underground concrete storage cellar or cave is one of the most practical solutions to the problem of economical and satisfactory storage of fruit and vegetables on the farm. Underground storage cellars maintain cool temperatures and relatively high humidity, tending to keep produce in good condition over a considerable period of time. Thus, a variety of home-grown fruit and vegetables may be had throughout the year.

Plans for a small underground storage are shown in Fig. 33. Walls of the small storage may

be of either concrete masonry units or of reinforced concrete. Storages of larger size should generally be of reinforced concrete construction. Construction of footings and walls is similar to that described under "Concrete Footings, Foundations and Basement Walls", pages 16 to 18. The reinforced concrete roof of the storage is supported during construction on temporary wood forms. The sheathing boards should be supported on 2x6 form joists, spaced 2 ft. on centers, the 2x6's in turn being supported on 4x4's or larger beams placed about 4 ft. on centers. The beams are supported at about 6-ft. intervals by a 4x4 or larger post properly braced and wedged tightly in position.

For greatest convenience, the storage cellar should be built into a side hill. This simplifies construction of the entrance and reduces labor in filling and emptying the storage. However, if the cellar must be located where the ground is nearly level, construction may be as shown in the plans.

Hotbeds and Cold Frames

Hotbeds and cold frames are similar in construction and both help make it easy to produce early vegetables or transplants. Fig. 34 shows suggested construction. Hotbed walls are built deeper into the ground than are cold frame walls, to make an enclosure for a filling of manure.

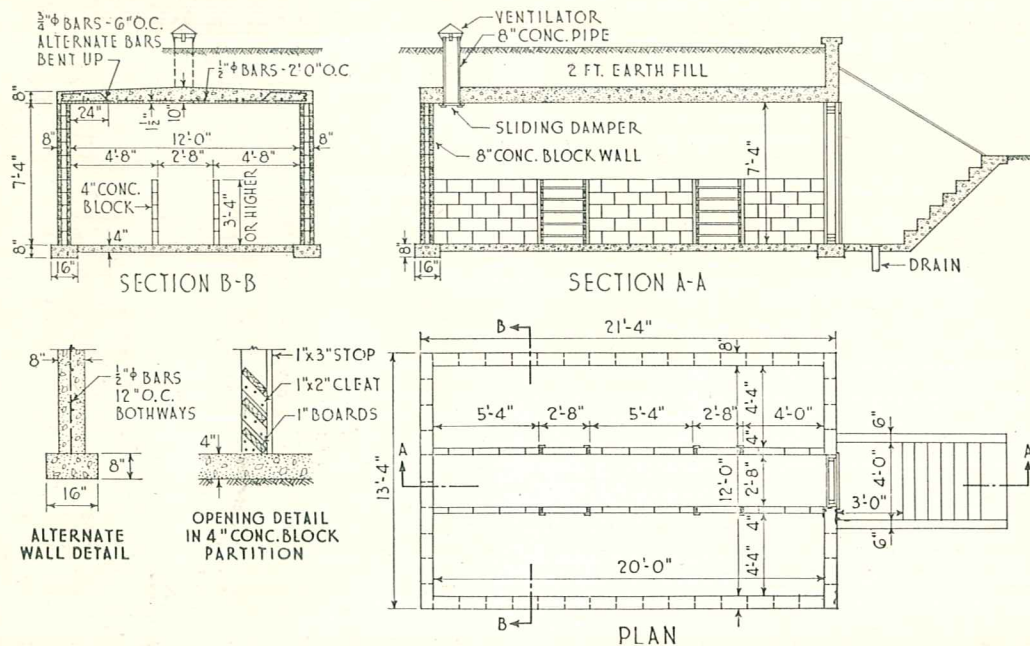
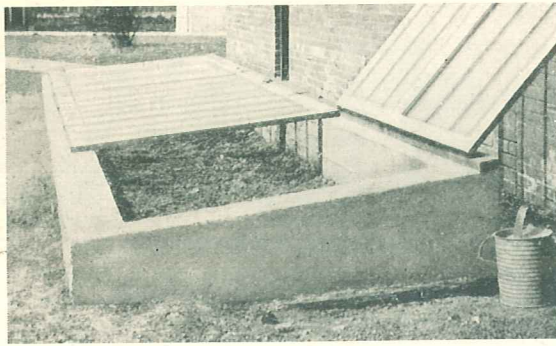

Fig. 33. Plans and suggested construction details of a small underground storage for fruit and vegetables.



Concrete hotbeds and cold frames are easy to build and help produce early transplants and vegetables.

A southern exposure for the hotbed or cold frame is desirable and if possible it should be located in a sheltered place. Drainage around the structure should be good. If the soil in the planted area is not well drained, 4-in. diameter drain tile may be placed around the bed and connected to a suitable outlet.

The excavation or pit for a hotbed is usually made about 1 ft. to 3 ft. deep, then manure and soil are placed as shown in the drawing. No manure is used in cold frames but the soil should preferably be of a sandy or sandy loam type so that it will warm up quickly under the sun's rays. Soil of this type also tends to have good drainage and it responds well to moderately light applications of fertilizer.

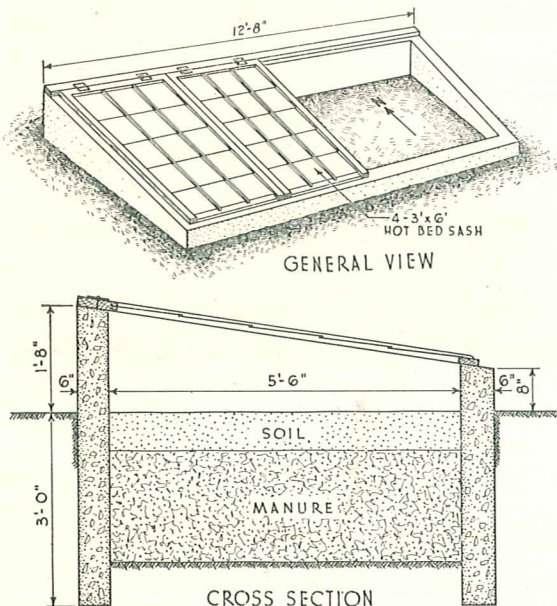

Fig. 34. Suggested construction of hotbeds and cold frames.

Chimney Caps

A chimney usually starts to deteriorate first at the top. New chimneys or those being repaired may be protected against such failure by properly installing a well built concrete chimney cap.

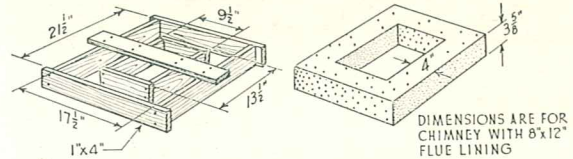

Fig. 35. Method of building concrete chimney cap. Outside dimensions of cap should be made the same as, or slightly greater than, outside dimensions of chimney.

Construction of the concrete chimney cap is shown in Fig. 35. The outside dimensions of the cap should be the same as, or slightly greater than the outside dimensions of the chimney. Side forms may be of 1x4 or 2x4 pieces. Core dimensions should be the same as the outside of the chimney flue.

A well built concrete chimney cap prevents the deterioration which usually starts at the top of the chimney.



The 1:2 $\frac{1}{4}$:2 $\frac{1}{2}$ concrete mix with $\frac{3}{4}$ -in. maximum size gravel is suggested. A $\frac{1}{4}$ -in. round reinforcing bar should be bent to form a square, then placed in the center of the concrete section. Lap bar ends about 10 in. An edging tool can be used to round the top edges of the cap if desired. After the concrete hardens for 2 or 3 days, forms may be removed, the inner form being withdrawn first. Portland cement mortar, consisting of 1 volume of portland cement to 3 volumes of mortar sand should be used in setting the cap on the top of the chimney.

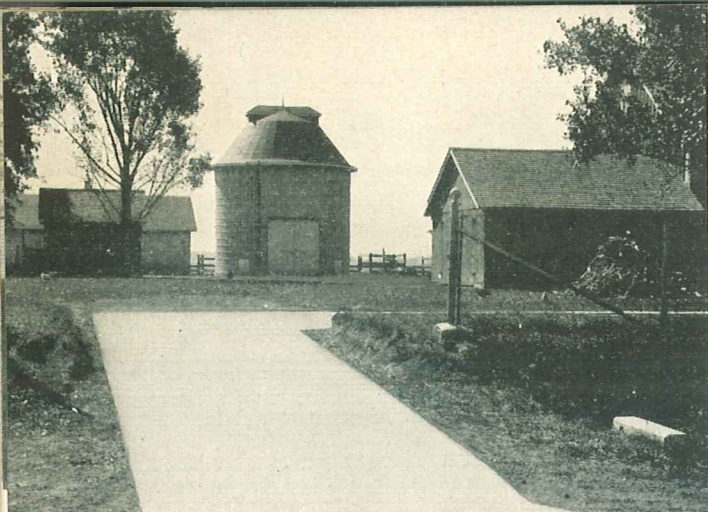

A concrete driveway assures that the entrance to the farm will be readily passable the year around and improves its appearance.

MISCELLANEOUS CONCRETE IMPROVEMENTS

Concrete Driveways

A concrete paved driveway assures that the entrance to the farm will be readily passable the year around. Suggested construction is illustrated in Fig. 36. Side forms may be of 2x6's for drives which are to accommodate only normal farm traffic, but if very heavy vehicles or machinery are to use the drive it is best to employ 2x8 side forms to make a thicker slab. Where 2x6 side forms are used, concrete is made about 5½ to 6 in. thick; with 2x8's about 7½ to 8 in. Most people prefer drives 9 or 10 ft. wide.

Concrete for the drive is placed and finished in much the same way as for concrete walks described on page 13. It is desirable, however, to have the drive slope toward the center as shown in the drawings. This provides good drainage and largely prevents washing and formation of eroding drainage channels along sides of the pavement. The desired slope is readily obtained using a strikeboard shaped to act as a templet (see drawings). The 1:2¼:3 concrete mix is suggested. Expansion joints are provided at about 20-ft. intervals by placing dividing strips of

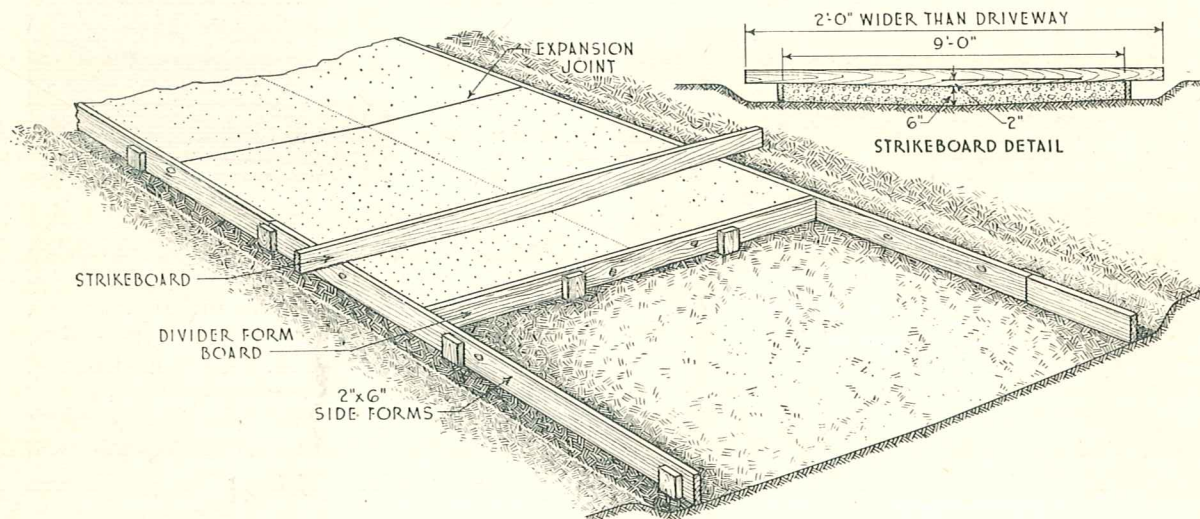
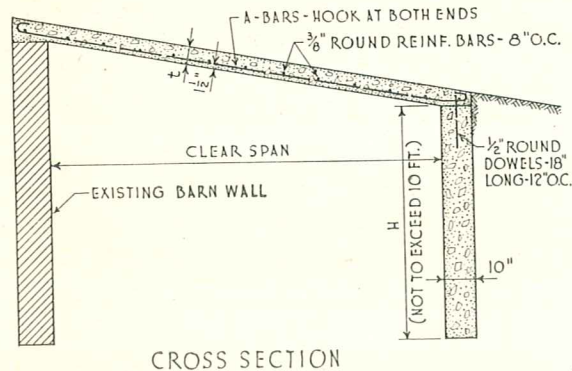

Fig. 36. Construction layout for concrete driveways.

tarred felt at right angles to side forms. Three or four thicknesses of roll roofing cut in strips the thickness of the pavement slab may be used for this purpose.

Barn Approaches

Concrete barn approaches may be built as shown in Fig. 37. With a concrete slab bridging



CROSS SECTION

Fig. 37. Suggested plan for concrete barn approach.

the distance from the earth-filled ramp to the foundation wall, the barn basement is not darkened and a passageway may be had alongside the barn under the bridge. An approach of this kind is especially convenient for basement type barns since it permits hauling directly onto the mow floor. An approach built according to the design shown will safely carry a loaded 4-ton



To reduce the fire hazard farsighted farmers are using more and more concrete in principal buildings. And for ample reserves of water in case of fire, many build a small concrete fire cistern. Plans for a 3,000-gal. farm fire cistern are available free on request in U. S. and Canada. This size is ample for the average farm.

truck, ample for ordinary farm requirements.

As indicated in the drawing, 1/2-in. round reinforcing bar dowels 18 in. long are set into the top of the abutment wall 12 in. on centers to help secure the deck slab to the abutment.

TABLE IX—Dimensions and Reinforcement for Concrete Barn Approach*
For design shown in Fig. 37

Clear span in feet	Thickness of slab in inches	Size and spacing of "A" bars required in slab
5	5	1/2-in. round reinf. bars 7 1/2 in. o.c.
8	5 1/2	1/2-in. round reinf. bars 5 1/2 in. o.c.
11	6	5/8-in. round reinf. bars 7 in. o.c.
14	7	5/8-in. round reinf. bars 6 in. o.c.

*All transverse reinforcing bars are 3/8-in. rounds placed 8 in. on centers.

Dimensions and reinforcement are shown in the drawings and in Table IX. The concrete slab is placed on temporary board forming supported on shores or posts which should be left in place at least 2 weeks while concrete hardens. Reinforcing bars should be kept up 2 in. off the forms and the heavy bars should be hooked at both ends as shown. This design should be used only in cases where *H*, the height of the abutment wall, is 10 ft. or less. Concrete side walls which enclose the earth fill for the ramp may be made 8 in. thick, whereas the main abutment wall should be 10 in. thick as shown.

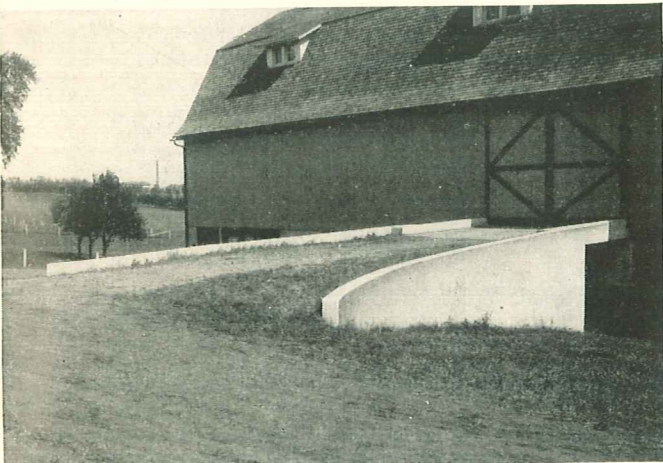

A concrete barn approach provides a safe, permanent entrance to the loft floor and provides light and ventilation along the stable wall below the approach.

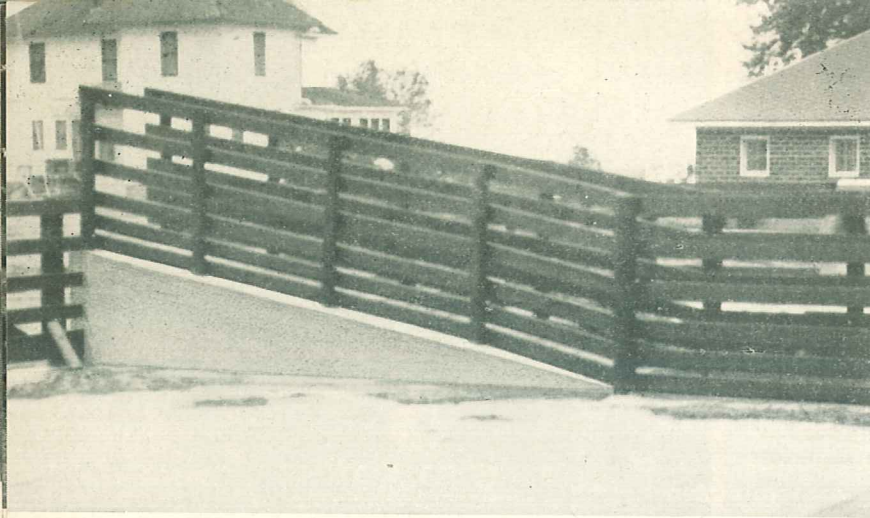

Concrete loading ramp for livestock. Ramps are not fenced if used principally for loading and unloading heavy implements and machinery.

Concrete Loading Ramps

Loading and unloading of cattle and hogs, heavy machinery and implements can be greatly simplified and speeded if a loading ramp is available. Construction of a permanent and practical loading ramp is illustrated in Fig. 38. If the ramp is to be used principally for loading and unloading livestock it is most convenient to build it in, or adjacent to, one of the fenced lots in the barnyard. In such cases the ramp is usually fenced as shown in the photograph.

Where the ramp is to be used only for loading of livestock it may be built 6 ft. wide, outside dimensions, which provides a clear passage about 4 ft. wide. Where the ramp is to be used for loading heavy implements and machinery it is

generally built 10 to 12 ft. wide. To be most convenient, the ramp should be built with a gentle slope, usually not steeper than a rise of 1 ft. in a length of 6 ft. horizontally. However, farm ramps commonly vary in slope from 1 ft. vertically in 8 ft. horizontally, to slopes of 1 ft. vertically in 5 ft.

horizontally. Height of ramp may be anywhere from 36 to 48 in. depending upon the height of the truck platform. The ramp is usually made of such height that it will accommodate the largest trucks which are to use it. Then for trucks with lower platforms pieces of plank may be laid on the pavement on the loading side of the ramp to raise the truck floor to the ramp level. A small concrete pavement for the loading side of the ramp as shown prevents truck wheels from bogging down under heavy loads or in soft earth. Construction of forms and placing and finishing of concrete for the ramp walls are accomplished in much the same manner as described under "Concrete Footings, Foundations and Basement Walls", pages 16 to 18.

Fig. 38. Method of building concrete loading ramp. If the ramp is used for loading livestock it is usually fenced as shown in the photograph above.

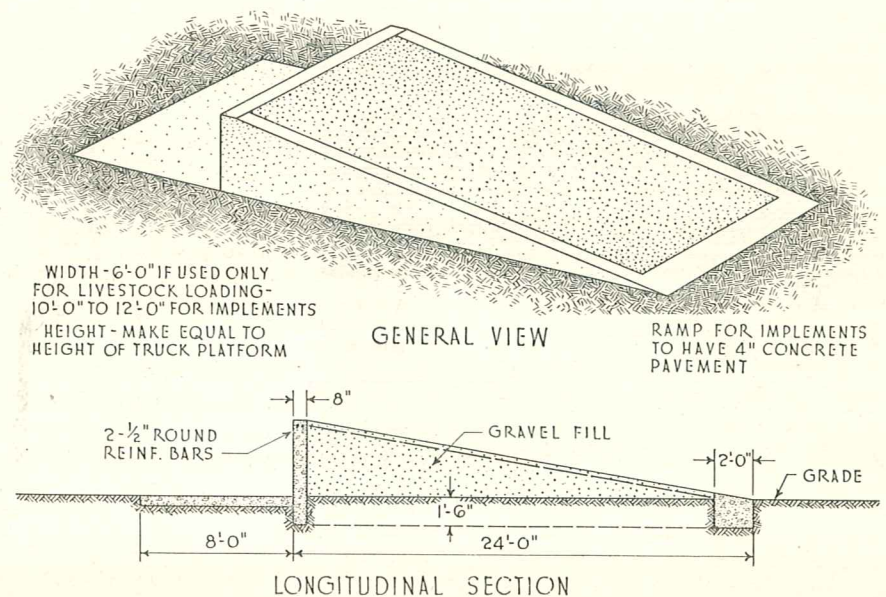

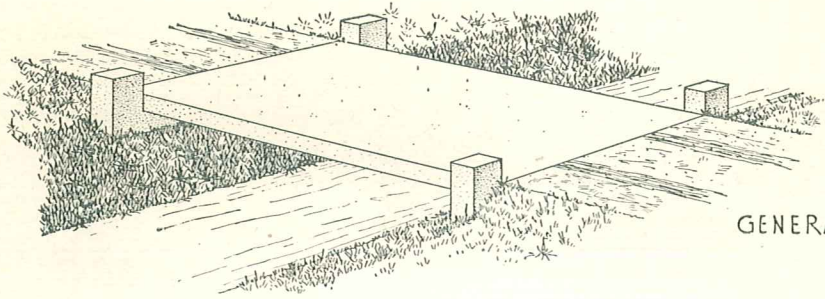

GENERAL VIEW

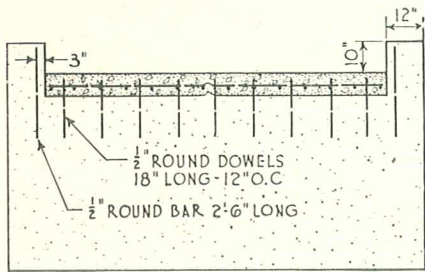

BUTTRESS ELEVATION

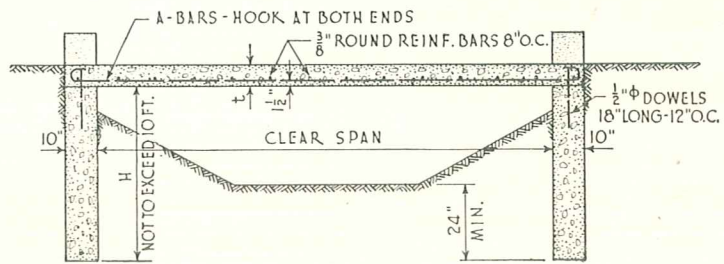

CROSS SECTION

Fig. 39. Suggested plans for small farm bridge.

Small Farm Bridges

A makeshift bridge is dangerous at best and requires constant and annoying repairs. It should be replaced with a strong, dependable concrete structure as shown in Fig. 39. A bridge built as shown here accommodates a 6-ton load, which is adequate for usual farm requirements. The straightforward design makes for simple construction readily handled on the farm. Dimensions and reinforcement are shown in Table X. It is especially important to extend the bridge abutments to a depth of about 2 ft. below the level of the creek bed or ditch bottom to prevent undermining by washing.

Concrete for the deck slab is supported on a platform of 1-in. form boards fastened to 2x6 joists spaced 2 ft. on centers. The joists are supported on 4x4's or larger timbers spaced about 4 ft. on centers. These timbers in turn are supported on shoring which is wedged and braced firmly in position. Building of forms for the concrete abutments is much the same as described for foundation walls on page 17. Construction of the bridge should be completed during dry weather, if possible, when the stream or ditch water level is low.

TABLE X—Dimensions and Reinforcement for Small Farm Bridge*

For design shown in Fig. 39

Clear span in feet	Thickness of slab in inches	Size and spacing of "A" bars required in slab
6	5½	5/8-in. round reinf. bars 8 in. o.c.
9	6½	5/8-in. round reinf. bars 7 in. o.c.
12	7	3/4-in. round reinf. bars 8 in. o.c.
15	8	3/4-in. round reinf. bars 7 in. o.c.

*All transverse reinforcing bars are 3/8-in. rounds placed 8 in. on centers.

This dependable slab bridge is typical of many farm bridges which provide lasting repair-free service. A simple design is shown in Fig. 39.

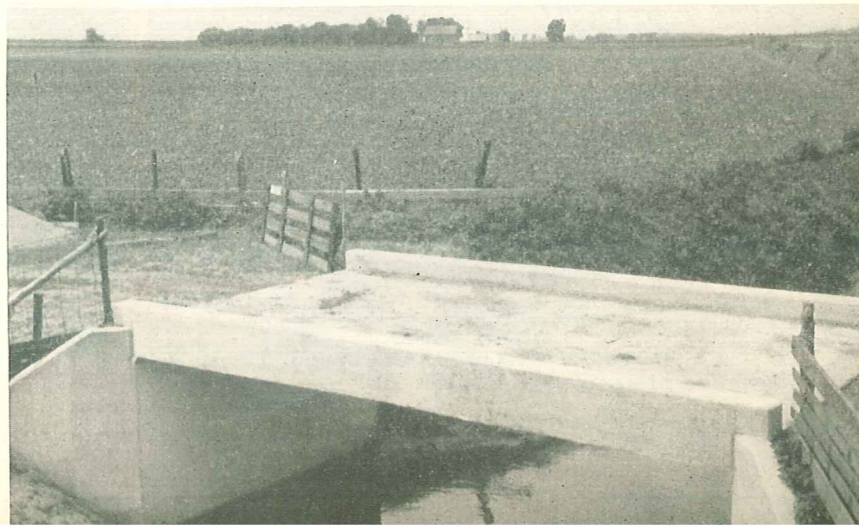

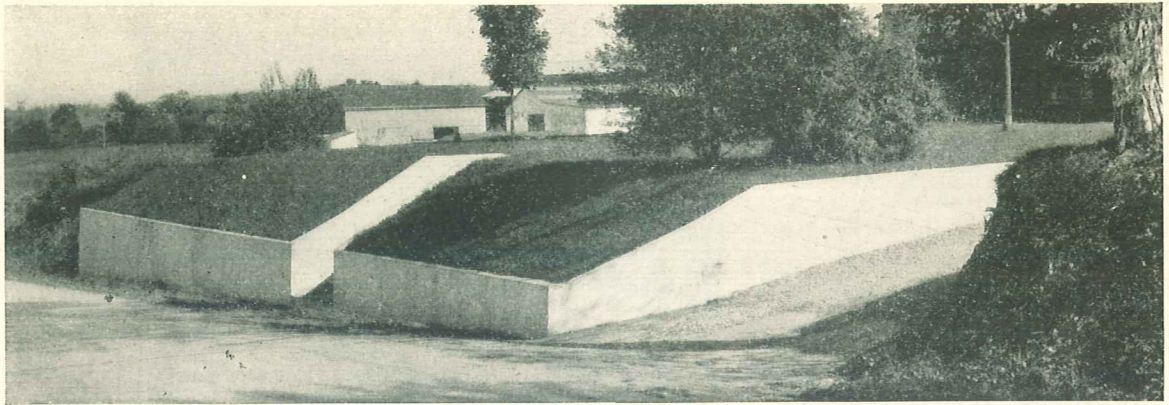

Where buildings are located on steeply sloping ground, concrete retaining walls may be built to prevent or remedy unsightly eroding earth embankments. Grass is easily grown on the resulting gentle slopes.

Retaining Wall Construction

Where the farm home or other buildings are located on steeply sloping ground, small concrete retaining walls may often be built to prevent or remedy unsightly eroding earth embankments. As shown in the photograph, concrete retaining walls give the yard a neat, trim appearance and make possible the growing of an attractive lawn on the resulting gentle slopes. Retaining wall construction is indicated in Fig. 40 and Table XI. Table XI also gives the cubic yards of concrete required per lineal foot of wall. A wide base is needed to prevent tipping of the wall. To obtain

TABLE XI—Dimensions of Retaining Walls

Height in feet <i>H</i>	Width of footing in feet <i>B</i>	Cu.yd. concrete required per lin.ft. of wall
3	2½	0.2
4	3	0.3
6	4	0.6
8	5½	1.0

smooth, concrete surfaces, care should be taken to use a workable, well proportioned concrete mix and to spade it carefully along form faces. Forms should be tight and smooth.

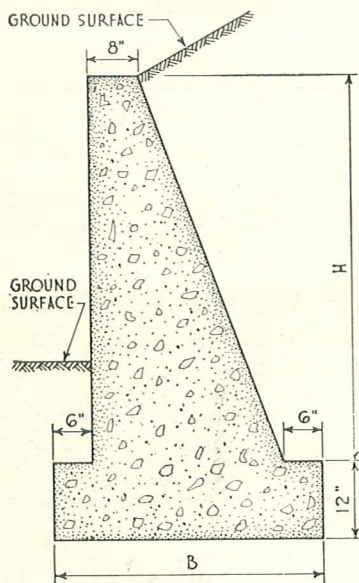
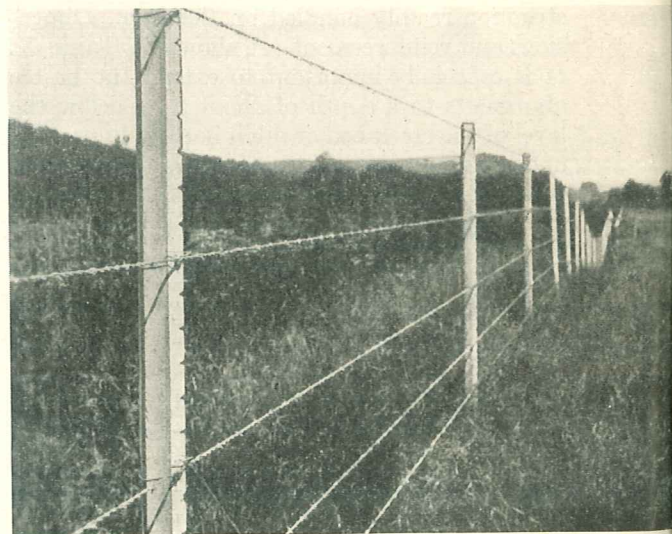

Fig. 40. Concrete retaining wall design. The wide base prevents tipping of the wall.



Small diameter concrete posts are rapidly driven by hand with a special driving sleeve (see text, page 54).

Concrete Fence Posts

Making concrete posts is an interesting job and one which produces useful, economical, lasting improvements. Concrete posts cannot burn, rot or rust. A fence built with concrete posts is virtually free from upkeep expense. Millions of concrete posts are in use on farms in this country.

That well made concrete posts last indefinitely

is attested to by the record of several hundred concrete posts erected in 1914 on the Iowa Agricultural Experiment Station farm at Ames, Iowa. These posts, after more than 25 years of service, are in excellent condition and will give good service for many more years (*see photograph below, left*).

Metal molds are most satisfactory for casting concrete posts if large numbers are to be built.

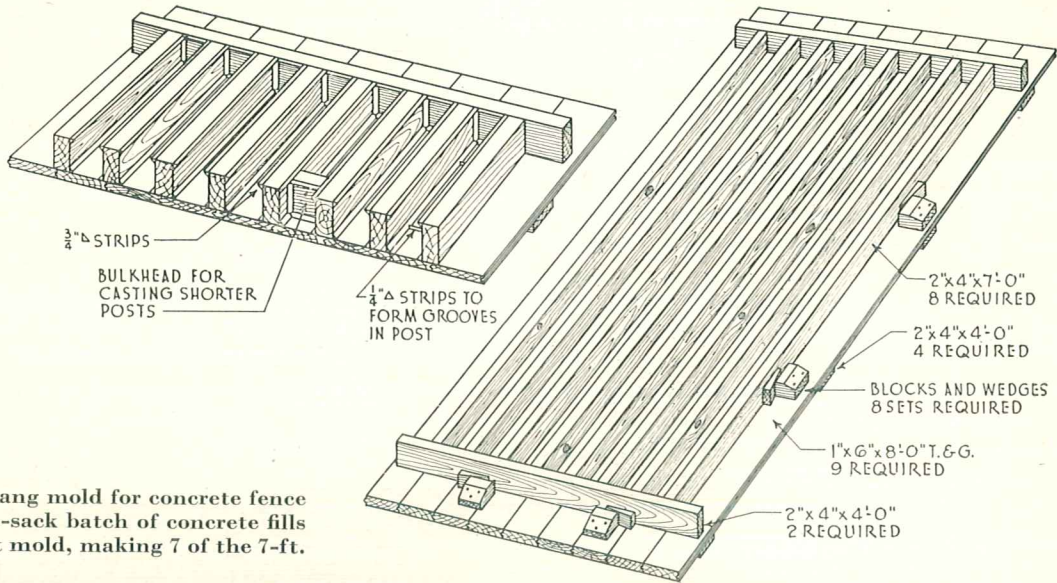
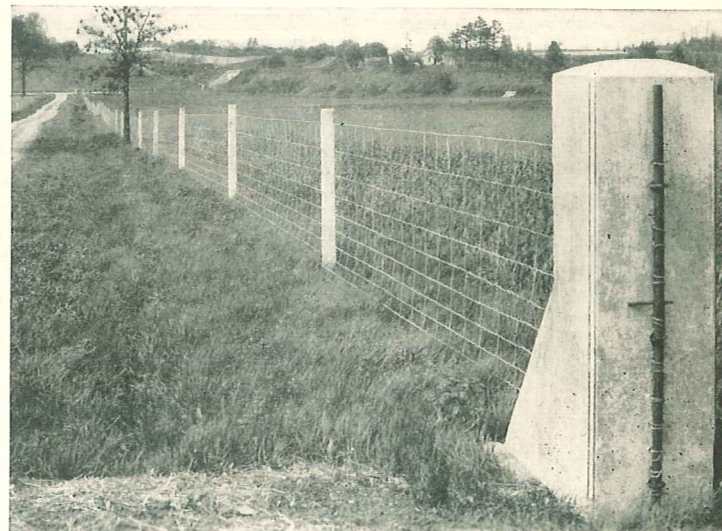

Fig. 41. Gang mold for concrete fence posts. A 1-sack batch of concrete fills the 7-post mold, making 7 of the 7-ft. posts.



These concrete posts, erected in 1914 on the Iowa Experiment Station Farm at Ames, were 25 years old when this photograph was taken. They will continue to give trouble-free service for many more years.



Sturdy concrete posts of this kind put an end to fence worries and fence repairs. When set 2½ ft. into the ground, quality concrete posts last for a generation.

Where only a moderate number of posts are being built, however, a simple gang mold as shown in Fig. 41 will prove satisfactory. A 1-sack batch of concrete makes 7 of the 7-ft. posts; thus a gang mold for casting 7 posts is convenient. Shorter posts are made by inserting bulkheads in the form as shown.

Molds should be assembled on a flat surface which has been painted with oil or covered with two or three layers of heavy, waterproof paper. Molds should be thoroughly coated with clean, thin oil before and after each use.

For a heavy duty concrete post, four $\frac{1}{4}$ -in. round reinforcing bars are used, one placed near each corner. However, a post which will meet average requirements may be reinforced with 4 No. 6 wires. The reinforcing bars or wires should be covered with not less than $\frac{3}{4}$ in. of concrete. If placed closer to the surface, reinforcement may rust causing the concrete to spall and thus shorten the life of the post.

Two of the reinforcing bars or wires for each post are cut 12 in. shorter than the length of the post and placed with the ends 6 in. from the top and bottom ends of the post. The other two bars or wires need to be only 3 ft. long, placed to extend from a point 18 in. below the ground line to a point 18 in. above it. Bars of equal length should be placed diagonally opposite each other.

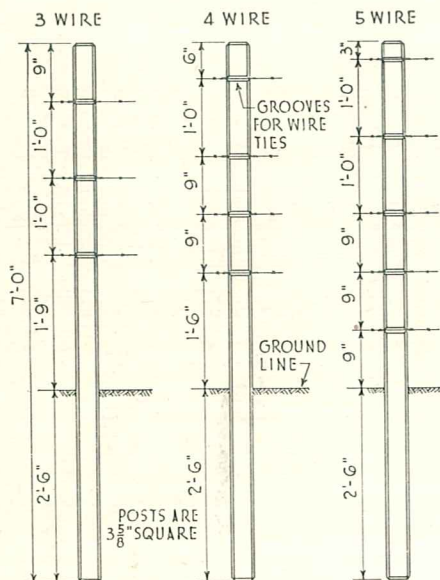

Fig. 42. Standard wire spacing for barbed wire fences.

The $\frac{1}{4}$ -in. triangular strips to form grooves in the post should be placed as required, depending upon fence wire spacing to be used (see Fig. 42). Where posts should be adaptable to various wire spacings, the groove strips may be placed on 9-in. centers from the ground line (2 ft. 6 in. from the lower end) to a point 18 in. above the ground line; then on 3-in. centers to the top of the post.

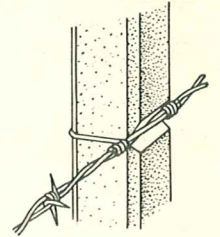

Fig. 43. Method of fastening fence wire in the grooves in concrete posts.

In erecting a fence, the wire ties hold the fence wires securely in the grooves (see Fig. 43). Line posts should be set at least 2 ft. into the ground; 2 ft. 6 in. is better. Corner posts should be well braced and set at least $3\frac{1}{2}$ ft. into the ground.

Posts are set in two ways: In holes dug to receive them or, if of small diameter, they can be driven with a special driving sleeve made from a piece of pipe of somewhat larger diameter than the post and about 3 ft. long. One end of the pipe is capped and cushioned by inserting an oak driving block. This method saves much time and labor in setting posts, particularly in soft or wet soils. Concrete fence posts are usually spaced 1 rod ($16\frac{1}{2}$ ft.) apart.

Using the suggested concrete mix, 1 sack portland cement to $2\frac{1}{4}$ cu.ft. sand to $2\frac{1}{2}$ cu.ft. gravel ($\frac{3}{4}$ -in. maximum size), the following materials are required for 100 posts each 7 ft. long:

- 15 sacks portland cement
- $1\frac{3}{4}$ cu.yd. sand
- $1\frac{3}{4}$ cu.yd. gravel
- 1,800 lin.ft. (177 lb.) No. 6 wire or
- 1,800 lin.ft. (300 lb.) $\frac{1}{4}$ -in. round bars

After concrete in the forms has been struck off and troweled lightly to make a smooth top surface, it should be left to harden for at least 48 hours, longer in cold weather. Molds are then taken apart and the new concrete posts are stored in a shaded place where they should be kept constantly wet by sprinkling for at least 10 days. Posts should be at least 1 month old before being hauled away and set in place.

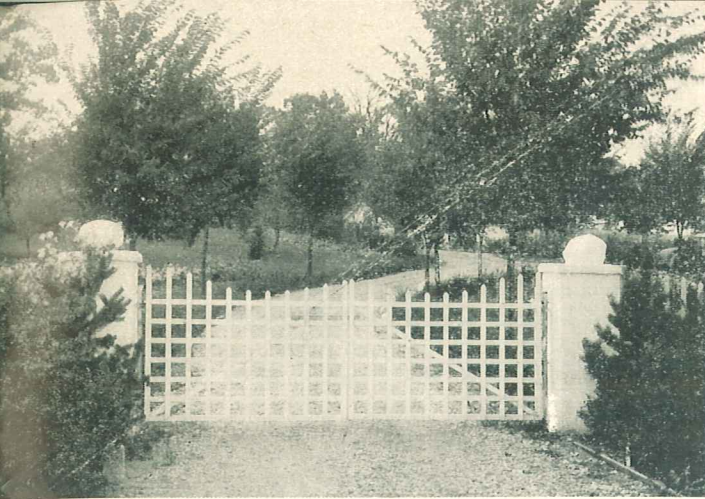

Attractive concrete entrance posts may be made of cast-in-place concrete or of concrete masonry units.

Corner Posts and Gate Posts

Corner posts, end posts and gate posts are made heavier and stronger than other posts to resist the greater strains imposed upon them. Suggested corner post construction is shown in Fig. 44. End posts and corner posts may be of similar design except that the concrete brace is needed on only one side of the end post.

In most soils the earth walls of the excavation may be used for forms below ground level. The trench for the concrete brace and the hole for the post should be dug at least $3\frac{1}{2}$ ft. deep. The trench can usually be kept narrow and true if dug with a tiling spade or other narrow spade. Forms needed above ground level are illustrated in the

drawings. The $\frac{3}{4}$ -in. triangular strips for lining corners of the form help make an attractive post with smooth beveled corners. If desired, quarter-round molding or cove molding may be used for this purpose. Decorative fluting for gate posts at the farm entrance may be provided by fastening triangular strips to the form faces in any one of a variety of patterns.

Heavy corner posts ordinarily do not need reinforcement, but if they are to be subjected to unusual strains, $\frac{1}{2}$ -in. round reinforcing bars may be placed in the concrete, one near each corner of the post. There should be at least 1 in. of concrete between the reinforcing bars and the surface of the concrete.

Fig. 44. Suggested form construction for concrete corner posts and end posts.

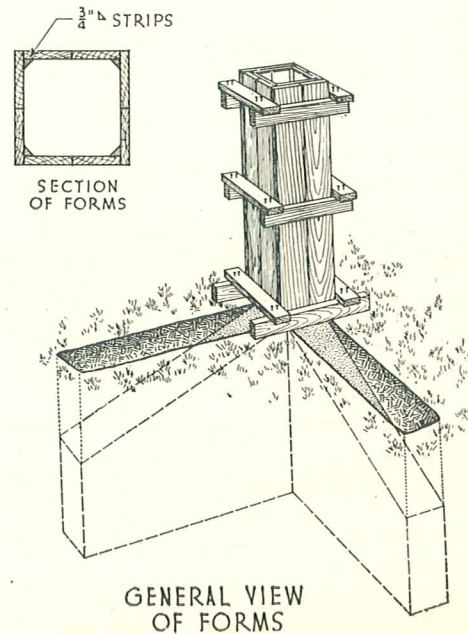
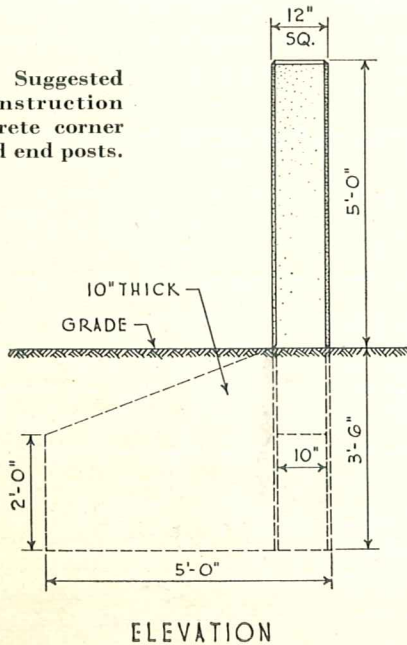

Electric Fences

Concrete fence posts are well suited for 1 or 2-wire electric fences. As with all other types of posts, the electric fence wire must be insulated from the post. A satisfactory method for fastening the wire is shown in Fig. 45. Insulators of the type shown are not expensive and should be used to assure dependable operation. A single strand of barbed wire is generally most satisfactory, the wire being placed at a height equal to three-fourths the height of the animal to be fenced in. Posts for electric fences are of two types as shown.

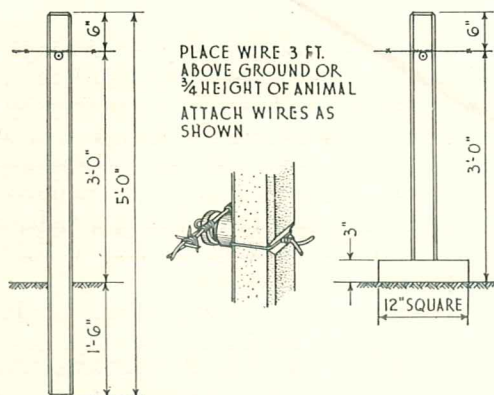
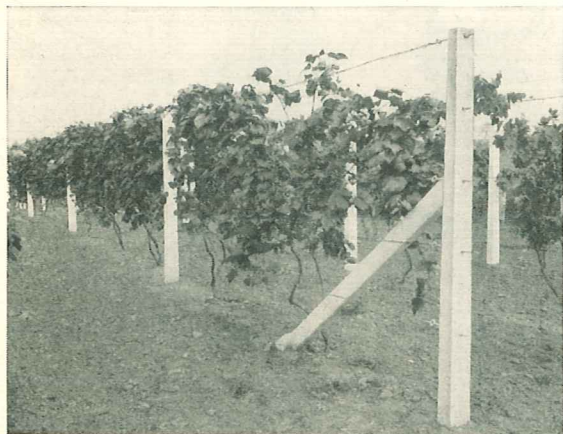

Fig. 45. Concrete posts for electric fences. Electric fence wire should be insulated from posts in this manner.

Vineyard Posts

Concrete posts for vineyards may also be made in gang molds of the type shown in Fig. 41. Length of posts and materials required are the



Concrete vineyard posts provide dependable supports and last indefinitely.

same as for all standard fence posts except end posts (see Fig. 46). Line posts are provided with holes through which smooth wires are threaded. The holes are formed (about 14 in. on centers) by inserting $\frac{1}{4}$ -in. greased dowels or bolts in the fresh concrete when the posts are cast. End posts should be well braced and reinforced with four $\frac{3}{8}$ -in. round bars. Vineyard posts are commonly set about 2 ft. in the ground and 12 to 16 ft. apart.

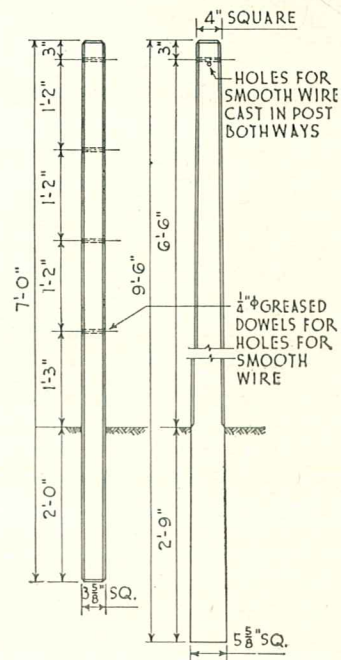

Fig. 46. Common dimensions of vineyard posts.

Clothesline Posts

Useful, sturdy, attractive clothesline posts are made as shown in Fig. 47. The 5-ft. cross arm may be made in the standard fence post mold and bolted to the main post. Hooks are cast into the arm as illustrated or $\frac{1}{4}$ -in. diameter holes may be made to receive the clothesline. The main post may be made in a mold similar to the fence post mold by using 2x6 side forms shaped to produce the taper required. Reinforcement of the main post consists of four $\frac{3}{8}$ -in. round reinforcing bars as indicated in the drawing. Clothesline posts are usually set $2\frac{1}{2}$ to 3 ft. deep and 30 to 40 ft. apart. The post may be increased to 10 ft. long where a 3-ft. deep setting is required. The following materials are required for 2 complete clothesline posts:

- 1 $\frac{1}{4}$ sacks portland cement
- 2 $\frac{1}{2}$ cu.ft. sand
- 3 $\frac{1}{2}$ cu.ft. gravel
- 42 lin.ft. (16 lb.) $\frac{3}{8}$ -in. round reinforcing bars

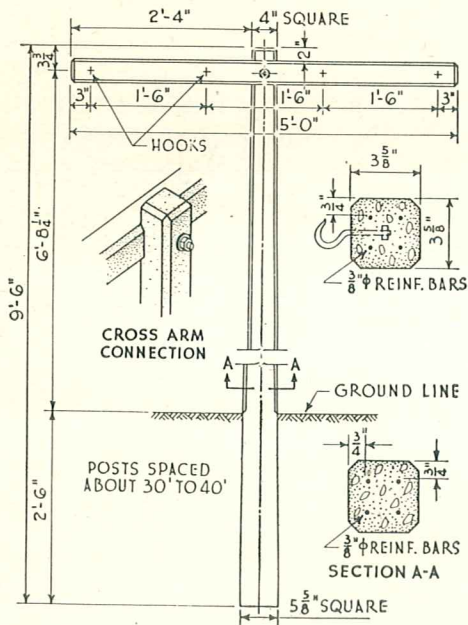

Fig. 47. Construction details for concrete clothesline post.

Sign Posts for Schools, Camps, Farms

Permanent concrete posts may readily be built to support signs. Sign posts are generally about 11 ft. 6 in. high to permit a 3-ft. deep setting

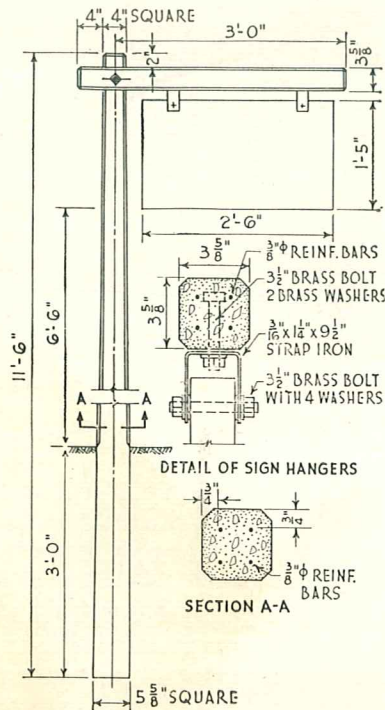

Fig. 48. Details of concrete sign post construction.

and to provide headroom under the sign. Method of forming and reinforcement is the same as for the clothesline post described above. As indicated in the clothesline post drawing, mortised joints 1/2 in. deep in the arm and in the post are provided when casting the concrete. The cross arm is then bolted to the post with a 3/4 x 7-in. machine bolt of brass or heavily galvanized to prevent rust stains (see Fig. 48).

Using the suggested concrete mix, the following materials are required for 1 sign post:

- 2/3 sack portland cement
- 1 1/4 cu.ft. sand
- 1 1/2 cu.ft. gravel
- 54 lin.ft. (20 lb.) 3/8-in. round reinforcing bars

Mailbox Post

A concrete mailbox post or standard is a sturdy, lasting improvement which adds to the tidy appearance of the yard (see photograph). Design details and method of building forms are shown in Fig. 49. Side forms may be of 1x4 boards assembled on a smooth platform as shown in the drawing. The post is made 4 to 5 in. wide at bottom, 3 to 4 in. at top, and reinforced with 1/4-in. round reinforcing bars. Holes for bolts which anchor the mailbox to the standard are formed by placing 3/8-in. greased dowels or bolts in the form as shown. Placing, finishing and curing concrete are accomplished in the same manner as for concrete fence posts.

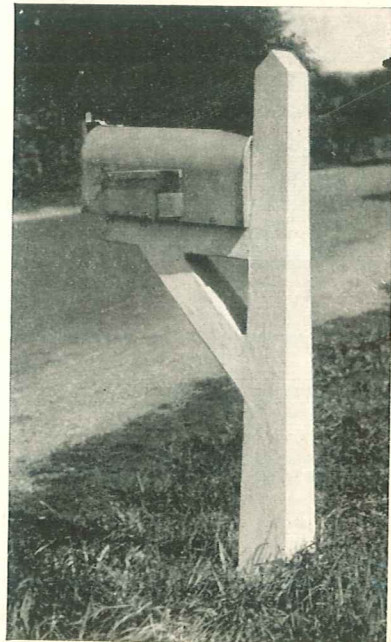

A concrete mailbox post is a sturdy, attractive improvement for the yard.

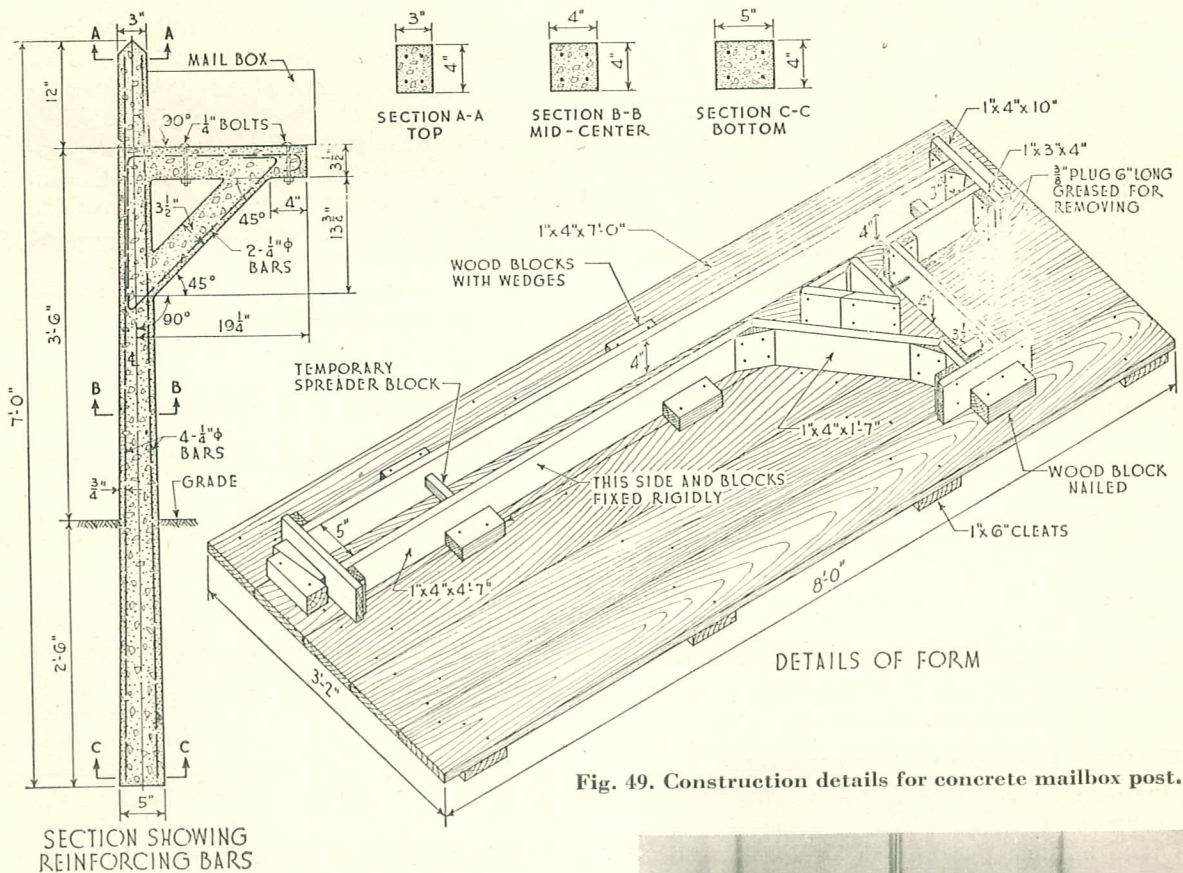

Fig. 49. Construction details for concrete mailbox post.

Milk Cooling Tanks

An insulated milk cooling tank is usually employed where milk regulations specify that milk be cooled rapidly to 50 deg. F. or lower. Size of tank required may be determined from Table XII.

Suggested construction of the insulated cooling tank is illustrated in Fig. 50. Forms are built in much the same way as those for stock watering tanks shown on page 32. Construction is as follows: The concrete base slab 4 in. thick is placed, then tank forms and insulation are in-

TABLE XII—Dimensions of Insulated Milk Cooling Tanks

Tanks are 36 in. wide, 27 in. deep inside (see Fig. 50)

No. of 10-gal. cans tank holds	Inside length	Outside length
4	4 ft. 0 in.	5 ft. 8 in.
6	6 ft. 0 in.	7 ft. 8 in.
8	8 ft. 0 in.	9 ft. 8 in.

For each additional 2 cans, increase inside and outside length of tank 2 ft.

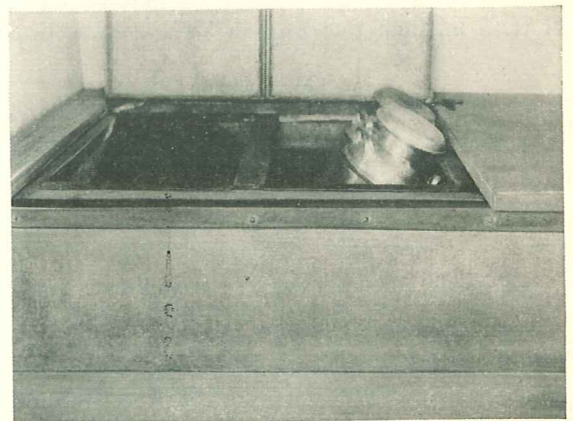

The insulated concrete cooling tank is economical to build and helps cool milk efficiently. Suggested construction is shown in Fig. 50.

stalled. The overflow pipe and other pipes are placed before concreting begins. In northern areas, drain pipes should be laid below frost level. Only high quality insulation board 3 in. thick put up in vaporproofed packages should be used. When necessary to cut a package, exposed edges should be dipped repeatedly in hot asphalt to secure a thoroughly waterproof seal. Every pre-

caution must be taken to keep insulation dry.

When wall forms have been filled with concrete, anchor bolts for attaching the rim planks and the 2x2 angle irons are set. Forms may be removed after concrete hardens for 24 to 48 hours. The new concrete should then be moist cured for at least 10 days.

Fig. 50. Suggested construction of insulated milk cooling tanks.

Ratproofing

Rats are expensive and dangerous farm pests. They transmit disease germs dangerous to both humans and livestock, they kill many young chicks and birds, destroy grain, damage buildings, and even cause fires by gnawing insulation from electric wires in buildings.

To thrive, however, rats must have a generous and constant supply of food as well as quiet places for hiding and breeding. If these essentials are taken away, rats will leave and seek surroundings more attractive to them. One of the most effective ways to rid the premises of rats is to build of ratproof construction.

Principal methods of ratproofing buildings are

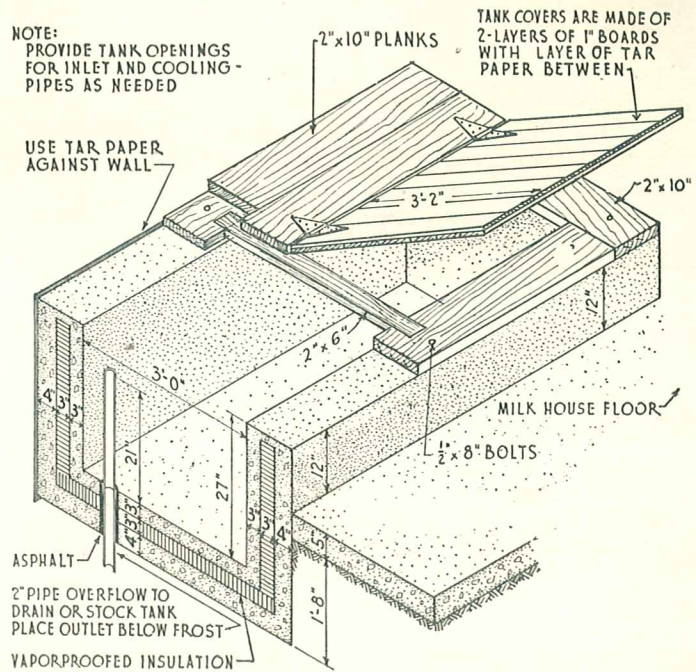

shown in Fig. 51. In general, well built concrete floors, foundations and walls are the most practical barriers to keep out rats. As indicated in the drawings, however, concrete and metal may be used to make buildings of frame construction ratproof. Rats often burrow to a depth of 2 to 2½ ft. so it is important that tight foundation walls extend to a depth of about 2½ to 3 ft.

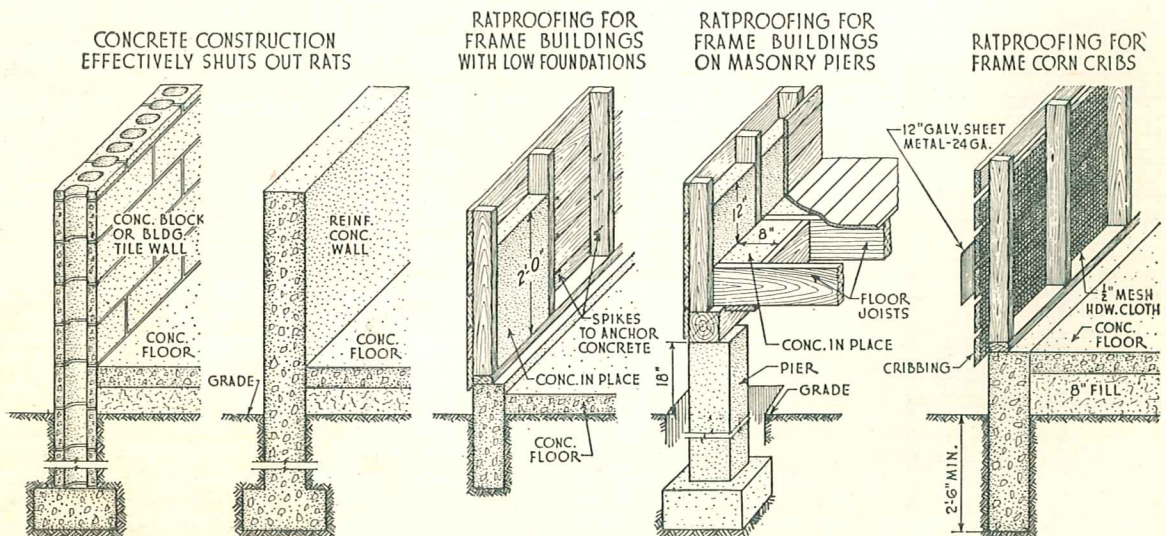

Fig. 51. Principal methods of ratproofing buildings.

Concrete Grain Bins

The natural advantages of concrete in grain storage construction are widely recognized since virtually all large grain elevators in the country are built of concrete. It is equally advantageous to build farm bins and granaries of concrete because concrete bins provide ideal storage conditions; they are dry, ratproof and safe against fire and wind storms.

It generally pays to have the larger farm bins and granaries built by competent concrete contractors or by a concrete stave manufacturer or builder of concrete stave grain bins or silos. Sug-

TABLE XIII—Horizontal Reinforcement and Wall Thickness Required for Square Bins*

Depth from top	Dimensions in feet		
	8x8	10x10	12x12
5 ft. or less	4 in. thick ½-in. round bars 8 in. o.c. Place 2 in. from outside face.	4 in. thick ½-in. round bars 6 in. o.c. Place 2 in. from outside face.	5 in. thick ⅝-in. round bars 9 in. o.c. Place 3 in. from outside face.
5 to 10 ft.	6 in. thick ½-in. round bars 12 in. o.c. Place 4 in. from outside face.	6 in. thick ½-in. round bars 8 in. o.c. Place 4 in. from outside face.	7 in. thick ⅝-in. round bars 9 in. o.c. Place 4½ in. from outside face.

*Vertical reinforcement is ⅜-in. round bars spaced 8 in. on centers. Distances from face of wall are to centerline of bars.

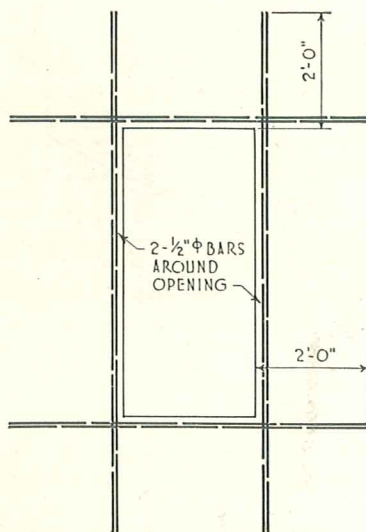

DETAIL OF REINFORCEMENT AROUND OPENING

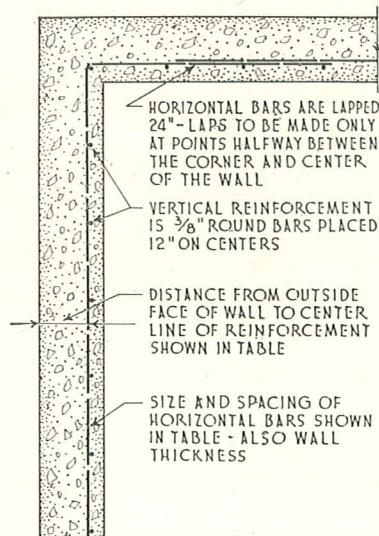

REINFORCING BARS SHOULD BE CAREFULLY PLACED AS INDICATED HERE

TABLE XIV—Capacities of Square Bins in Bushels*

Depth of bin in feet	Dimensions of bin in feet		
	8x8	10x10	12x12
4	200	320	460
6	310	480	690
8	410	640	920
10	510	800	1,150

*Capacities computed to nearest 10 bu., assuming 1.25 cu.ft. per bu.

gested types of grain storage structures, construction information and other useful data are given in free booklet, *Concrete Grain Storages for the Farm**, available on request.

Small, square concrete bins can readily be built with regular farm labor, however, if care is taken to make quality concrete and to provide the reinforcement suggested here. Grain bins should be made of watertight concrete which is obtained by employing the 1:2¼:3 mix, together with good workmanship as outlined under "How To Make Quality Concrete". Dry concrete floors in the grain bins can readily be built as described in "Concrete Floors, Walks and Pavements" (see page 11).

Proper reinforcement for square bins of different sizes is given in Table XIII. This table also shows required wall thicknesses and position of reinforcement. Method of placing reinforcement and lapping bars is illustrated in Fig. 52.

Vertical reinforcement consists of ⅜-in. round bars placed 12 in. on centers for all sizes of bins. Horizontal reinforcing bars are securely wired to vertical reinforcement. At laps, bar ends should extend 24 in. past each other and laps should be made only at points half-way between the corners and the center of a wall. Special reinforcement is required around openings in concrete bins as shown. Capacities of square bins are given in Table XIV.

*Free in U. S. and Canada.

Fig. 52. Details showing how to place reinforcement in walls of small, square grain bins and how to lap reinforcing bars.

With this type of bull pen the herd sire has the advantages of ample exercise out-of-doors, yet he is safely confined behind strong concrete posts and pipe rails. Method of casting pipes into concrete posts is illustrated at the right.

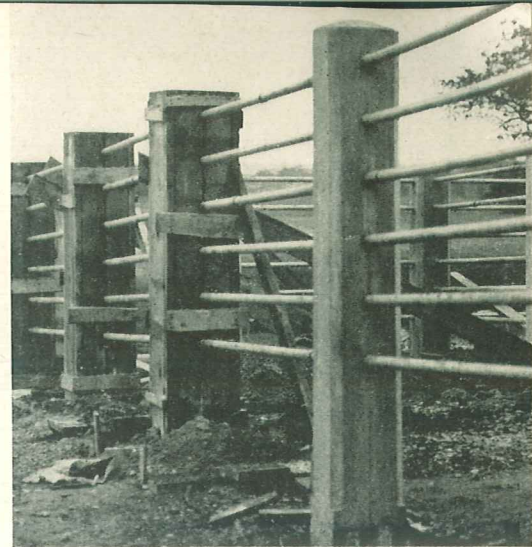
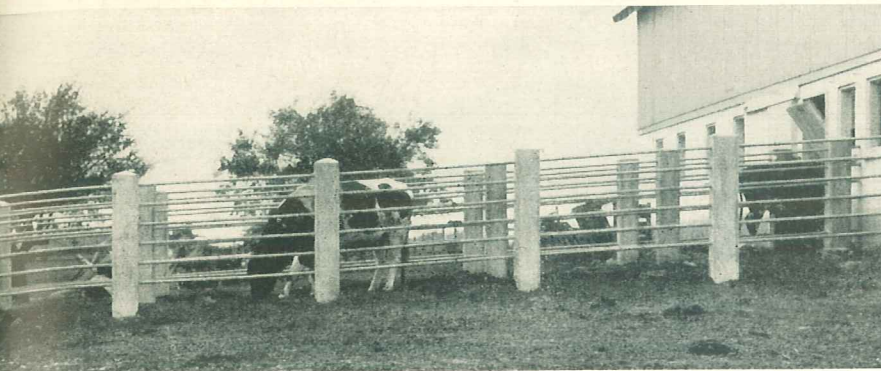

Safe Bull Pens

A substantial bull pen or paddock which permits sunlight, exercise and safe confinement for the herd bull is considered a necessity on the modern dairy farm. General practice is to enclose a space about 20x80 ft. Construction may be as shown in Fig. 53 and in the photograph. Concrete

posts are usually 8 or 10 in. square and 8 ft. long; $\frac{3}{4}$ -in. triangular strips are used to line corners of the post forms. The posts are set about 8 ft. apart and $2\frac{1}{2}$ ft. into the ground. Rails of $1\frac{1}{2}$ -in. galvanized pipe are fastened to the posts with "U" bolts, or the pipes may better be cast in place along the centerline of the post as shown.

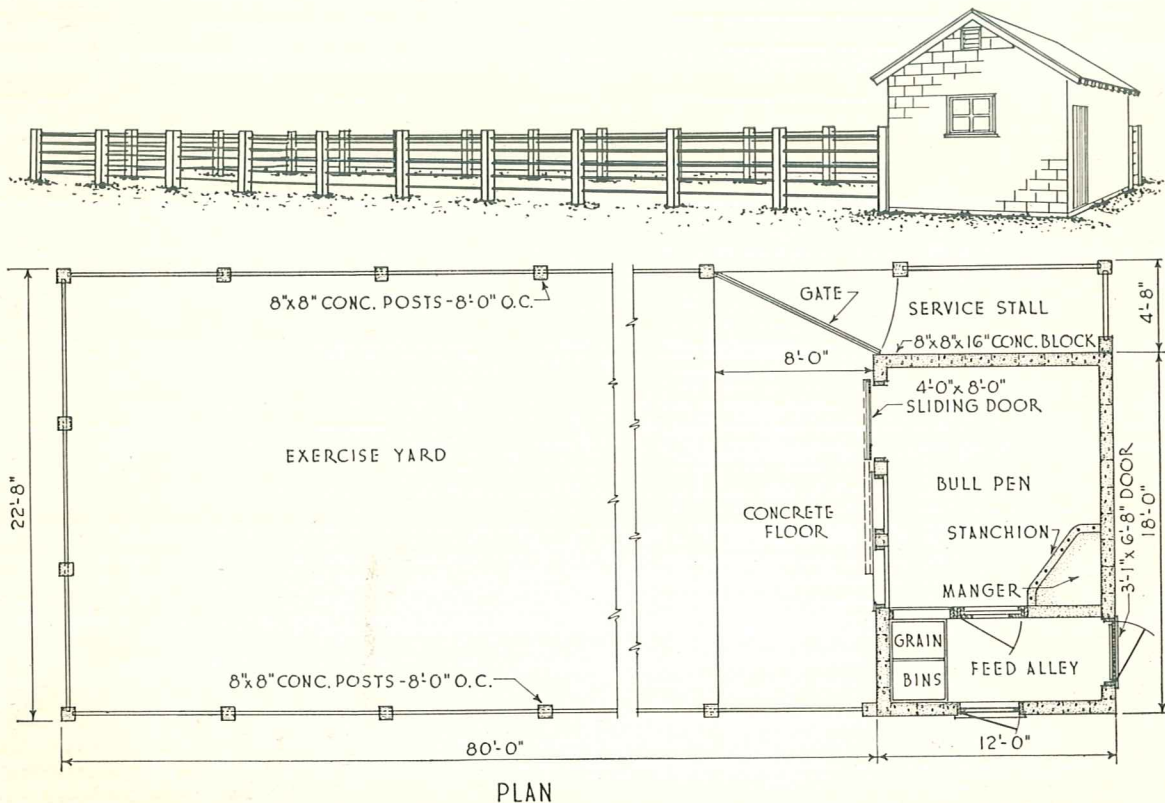
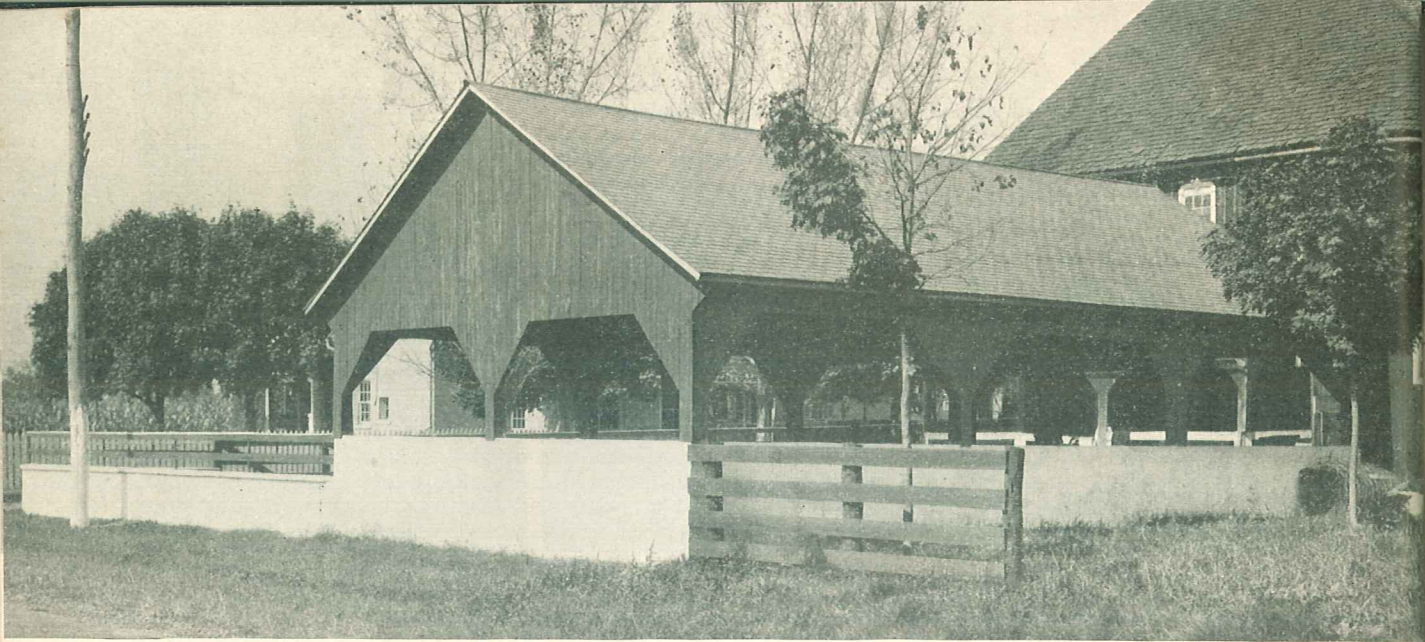

Fig. 53. Method of building a safe bull pen.



Fertilizing value of farm manure can be increased 100 per cent by proper storage and handling (see text).

Concrete Manure Pits

A concrete manure pit soon pays for itself by helping to conserve fertilizing elements which would otherwise be lost or destroyed. Farm manure is valuable chiefly for its nitrogen, phos-

phorus and potassium content. However, if manure is piled in an unpaved yard exposed to sun, wind and rain a large part of the valuable fertilizing elements is lost.

How this fertility can be saved to enrich the

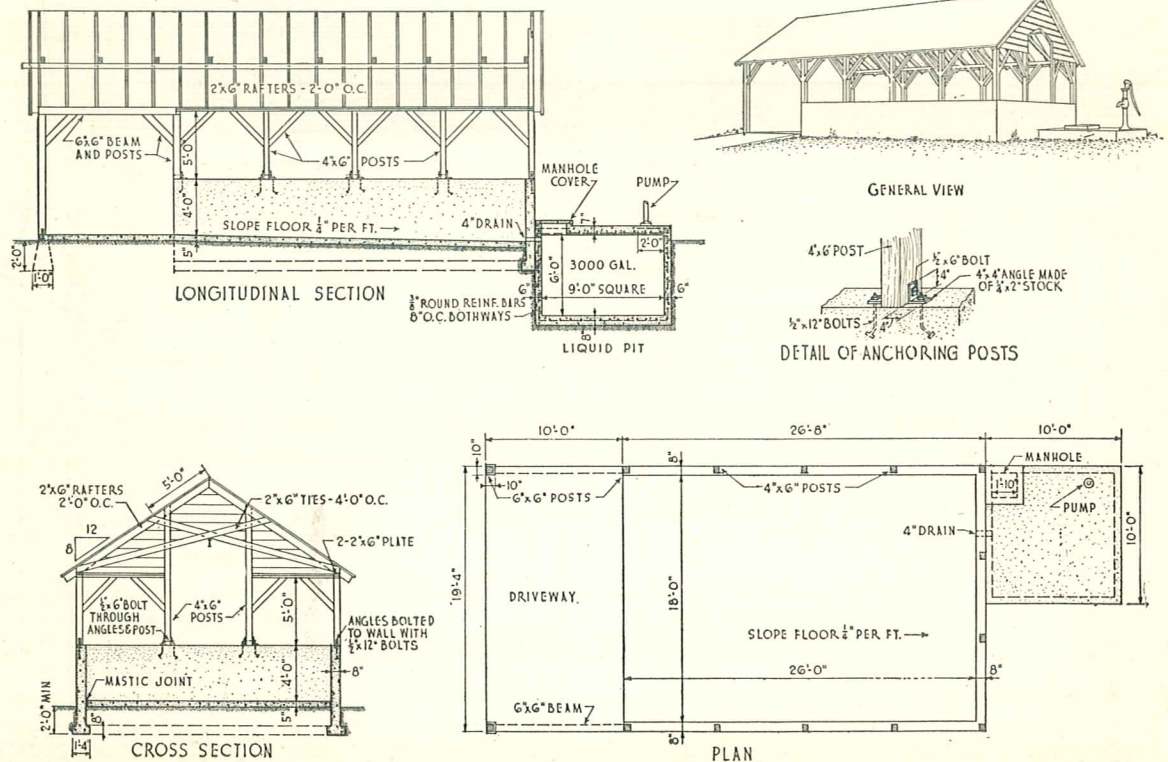
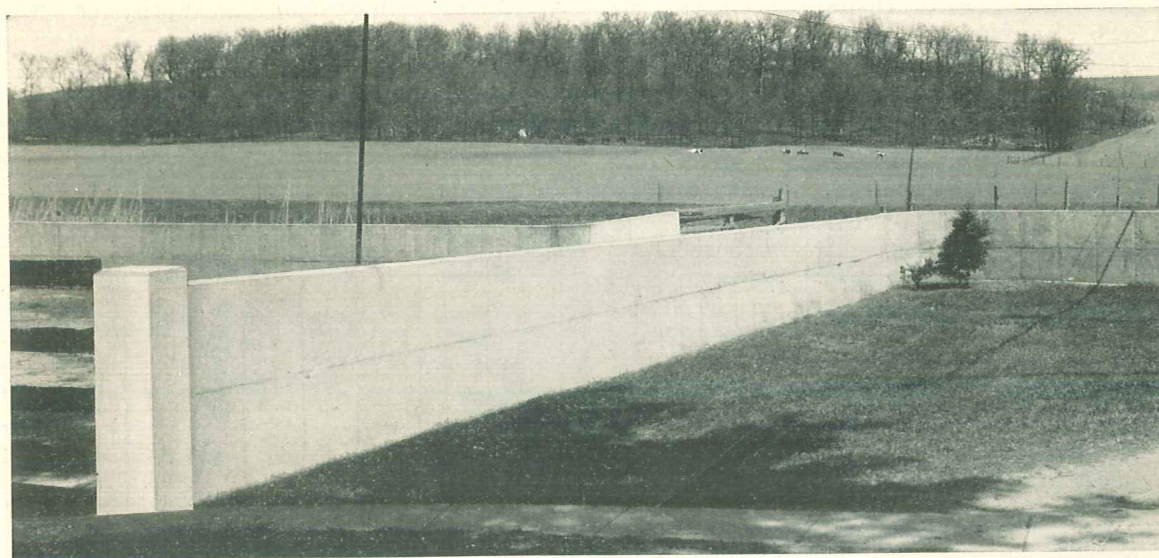

Fig. 54. Plans for concrete manure pit with liquid tank.

soil has been demonstrated by many good farmers and several agricultural experiment stations. Only two things are required to save most of the nitrogen and practically all of the phosphorus and potassium in manure: (1) generous use of bedding to absorb liquids which contain the larger part of the fertilizing elements, (2) storage of manure in damp, well compacted piles in a watertight, weather-protected pit. *These two practices, if followed faithfully, will double the fertilizing value of farm manure.*

A concrete manure pit is a practical solution to efficient handling of manure. Suggested construction is shown in Fig. 54. The increased value of manure properly handled will generally repay the cost of the pit during the first year or two of its use. A concrete pit is built 4 ft. high with lengths and widths to accommodate the size of herd as follows:

- 10 cows—16 ft. wide, 16 ft. long
- 20 cows—18 ft. wide, 26 ft. long
- 40 cows—24 ft. wide, 40 ft. long



A concrete wall for the barnyard provides a sheltered place for livestock on wintry days. Being permanent, the concrete wall also puts an end to annoying yard fence repairs. The wall may be of concrete masonry or of reinforced concrete construction as shown here.

Concrete Trench Silos

A generous and dependable supply of high quality roughage through winter months and through periods of severe drouth often makes the difference between success and failure with the dairy or livestock enterprise. Corn, hay or cane silages are valuable roughages which can readily be put into the trench silo at low cost to assure ample feed supplies.

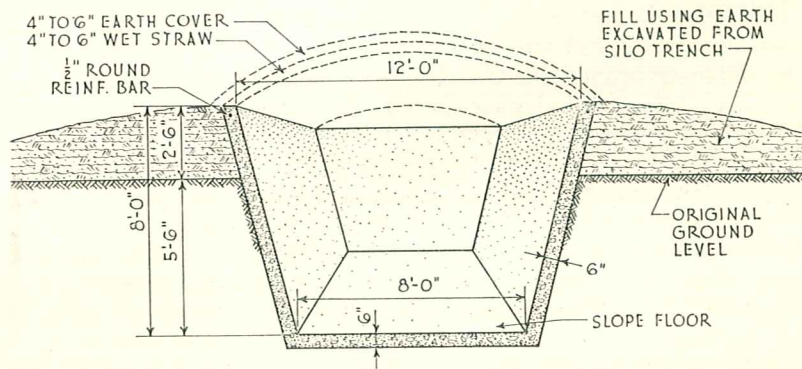
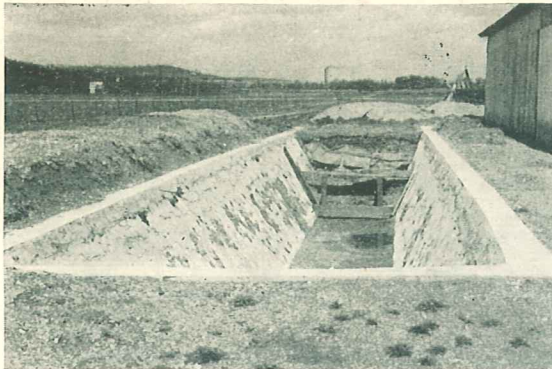

Fig. 55. Cross section of typical concrete trench silo. See dimensions in Table XV according to capacity of silo desired.



Typical trench silo with cast-in-place concrete walls.



A trench silo with portland cement plastered walls.

Fig. 55 shows suggested construction of the trench silo with a permanent concrete lining for best preservation of the silage. Although the trench silo is often used without lining, experience shows that in most silos it is necessary to install a concrete or other masonry lining within a few seasons. Otherwise the earth banks begin to slough away causing spoiled feed and great inconvenience in handling the silage.

Where underground drainage is excellent some prefer to apply a 3-in. coating of portland cement plaster to the sides of the trench, this coating being reinforced with heavy hog wire or $\frac{1}{4}$ -in. round reinforcing bars spaced 12 in. on centers each way. A concrete floor is almost a necessity to permit convenient hauling out of the trench during wet weather. A roof is not ordinarily considered necessary where the trench is lined with concrete. Common practice is to cover the silage in the trench, first with 4 to 6 in. of wet straw, then with about the same thickness of dirt. Well compacted silage of proper moisture content keeps in good condition with this covering.

If possible the trench silo should be located on well drained sloping ground near the barn or feed lots. Drainage around the trench is further improved by filling and sloping the banks of the trench as shown in the drawing. Earth is usually excavated and moved with a slip scraper or Fresno. The concrete floor of the trench silo should be sloped at least $\frac{1}{4}$ in. per foot to drain.

Size of trench silo to build may be determined from Table XV. Trench silo capacities in this table are based on filling with mature corn silage of average moisture content which when compacted weighs about 35 lb. per cu.ft. The amount of silage needed, as shown in the table, is on the basis of feeding 35 lb. of silage per animal per

TABLE XV—Size of Trench Silo to Build*

On basis of corn silage, feeding 35 lb. of silage per animal per day for 180 days and with silage averaging 35 lb. per cu.ft.

No. of cows or 2-year-old steers	Tons of silage needed	Width in feet		Length in feet
		Top	Bottom	
5	16	8	6	22
10	32	10	7	27
20	63	12	8	45
30	95	13	9	61
40	126	14	10	75
50	158	15	11	95
75	236	16	12	97
100	315	17	12	124

All silos to be 8 ft. deep except 5-cow size which is 6 ft. deep and silos for 75 and 100 head which are 10 ft. deep.

*Young stock often require additional tonnage equal to about one-half the amount provided for mature cattle. In such cases increase size of silo accordingly.

day for a season of 180 days. In figuring the size of trench to build, however, it should be remembered that young stock often require additional tonnage equal to about one-half the amount provided for mature cattle. It may also be necessary to increase the size of the trench if it is planned to keep a reserve supply of feed in the silo to meet emergencies such as a severe drought.

Where silage is made from overly-mature corn put up rather dry, the size of the trench must be increased 10 to 20 per cent to obtain required tonnages shown in the table. In the case of immature corn, which is very well eared, the size of silo can be decreased 10 to 15 per cent for tonnages shown in the table.

Dipping Vats for Cattle, Hogs and Sheep

A liquid-tight, concrete dipping vat is almost indispensable where large numbers of livestock are to be dipped. Suggested construction is shown in Fig. 56.

This type of dipping vat is suitable for cattle, hogs or sheep. Proper dimensions of vats for

each kind of animal are given in Table XVI. Watertight concrete should be made and reinforcement shown should always be installed to help assure a durable, liquid-tight vat. A small sump is usually built to receive dip which drains from the dripping pen floor and to return it to the dipping vat.

TABLE XVI—Dimensions of Dipping Vats
For design shown in Fig. 56

	A	B	D	E	F	W	N
Cattle.....	14 ft. 0 in.	14 ft. 0 in.	7 ft. 0 in.	4 ft. 6 in.	2 ft. 6 in.	3 ft. 0 in.	2 ft. 0 in.
Hogs.....	8 ft. 0 in.	10 ft. 0 in.	4 ft. 6 in.	2 ft. 6 in.	2 ft. 0 in.	2 ft. 0 in.	1 ft. 4 in.
Sheep.....	8 ft. 0 in.	8 ft. 0 in.	4 ft. 6 in.	2 ft. 6 in.	2 ft. 0 in.	2 ft. 0 in.	0 ft. 9 in.

Concrete dipping vat for cattle. Liquid-tight concrete vats are used where it is necessary to dip large numbers of cattle, hogs or sheep.

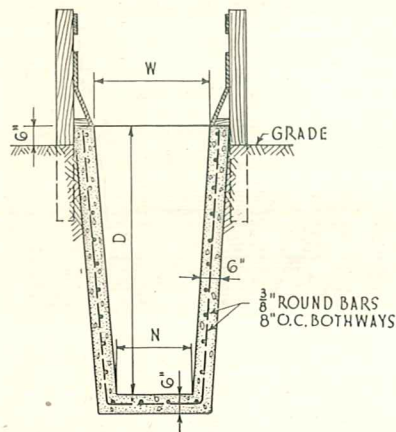

CROSS SECTION

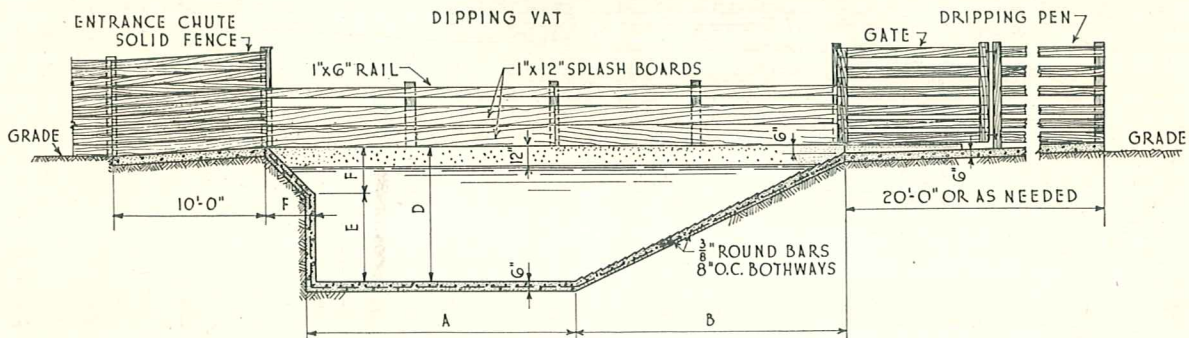
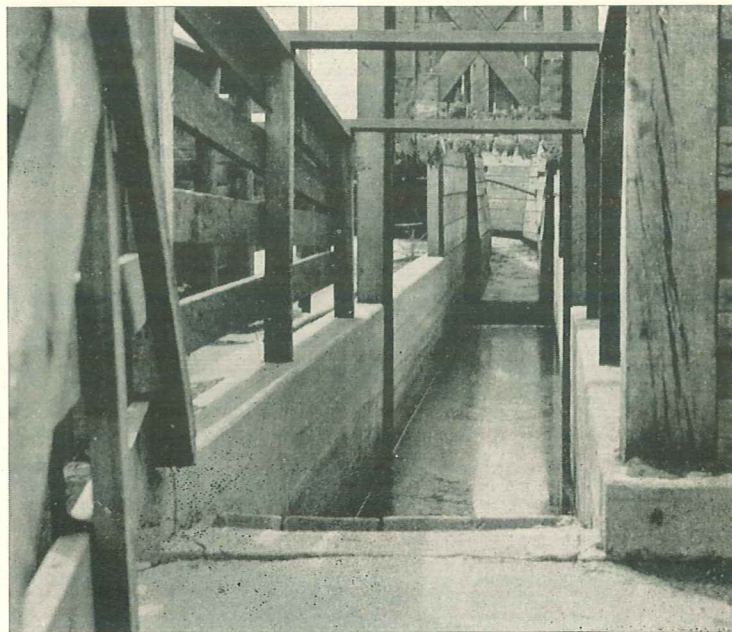

LONGITUDINAL SECTION

Fig. 56. Longitudinal and cross sections of typical concrete dipping vat. Proper dimensions of vats for cattle, hogs and sheep are given in Table XVI.

Cattle Feed Bunks

Cattle feed bunks must be of sturdy construction to withstand the hard usage encountered in the feed lot. Plans for a strong, permanent concrete feed bunk which is easily kept clean are shown in Fig. 57.

Where the feed lot is paved the legs or supports for the bunk are made by placing 8x8x8-in. concrete pier blocks as shown, then forming is in-

stalled as shown for the reinforced concrete feed trough. Dimensions of the feed bunk may be altered to fit individual conditions. The bunk may be from 3 to 5 ft. wide, from 2 to 3 ft. high and in such lengths as needed to meet requirements. Where the concrete feed bunk is built for an unpaved lot, small concrete footing piers should be built under each support as shown in the alternate construction detail.

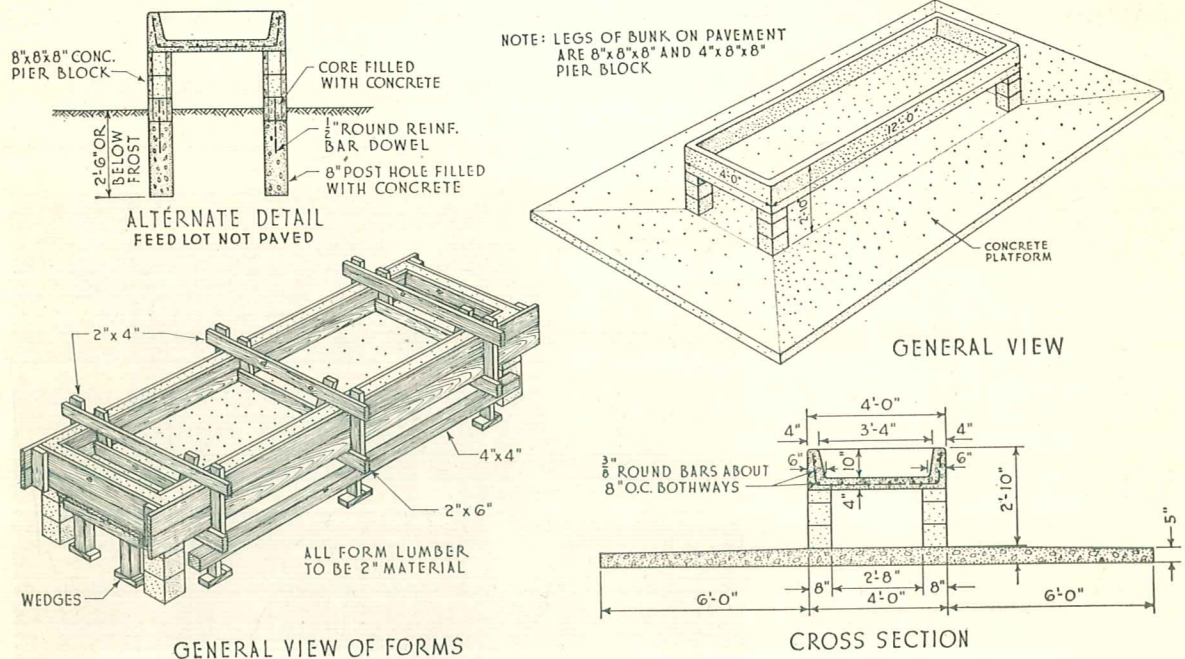

Fig. 57. Suggested method of building concrete cattle feed bunk.

Concrete Hog Wallow

Hogs have very few sweat glands, thus they need an abundance of water and shade to keep cool in hot weather. With access to a clean concrete wallow, hogs gain faster and require less feed per 100 lb. of gain than where a wallow is not available.

TABLE XVII—Size of Hog Wallow Required

No. of head in herd	Width in feet	Length in feet
15	10	12
25	14	16
50	18	20
75	22	24
100	26	28

A concrete hog wallow kept filled with clean water provides the refreshment hogs need in hot weather.

Size of wallow to build is readily determined from Table XVII. The wallow should be located adjacent to the feed lot and for best results good shade should be provided nearby. Suggested construction of the wallow is shown in Fig. 58. Provision for clean-out should be made in some way as shown so that the wallow can be kept in a sanitary condition. A small piece of paving around the wallow helps in maintaining a clean condition and prevents undermining of the structure.

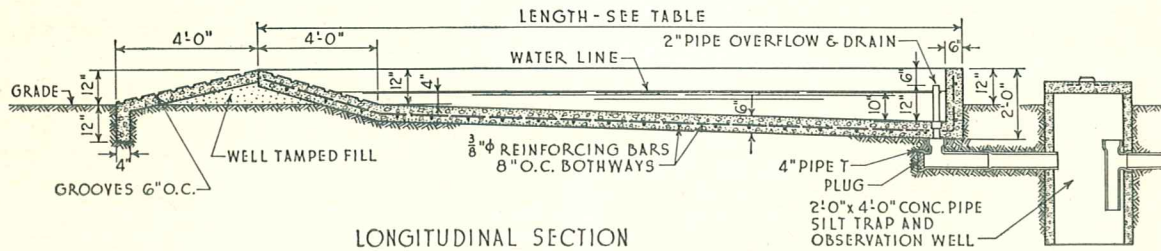
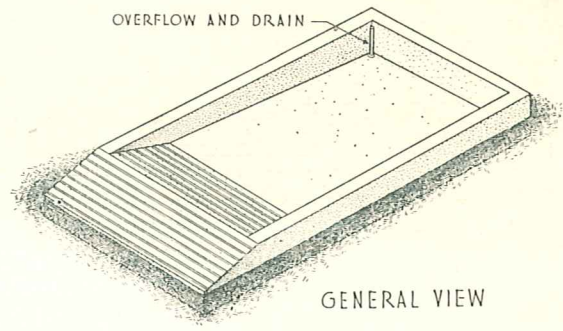

Fig. 58. Suggested construction of sanitary concrete hog wallow.

Hog Trough and Automatic Waterer

Concrete hog troughs last indefinitely, they are easy to keep clean and cannot be tipped or moved about by the hogs. Construction is relatively simple as shown in Fig. 59.

It is suggested that the 1:2 1/4 :2 1/2 concrete mix with 3/4-in. maximum size gravel be used. As concrete is being placed, it should be spaded and

tamped moderately to assure smooth concrete surfaces.

Plans for an automatic concrete waterer for hogs are shown in Fig. 60. Where running water is available the automatic waterer greatly reduces work of caring for the herd and hogs make faster and cheaper gains if they have access to an ample supply of water.

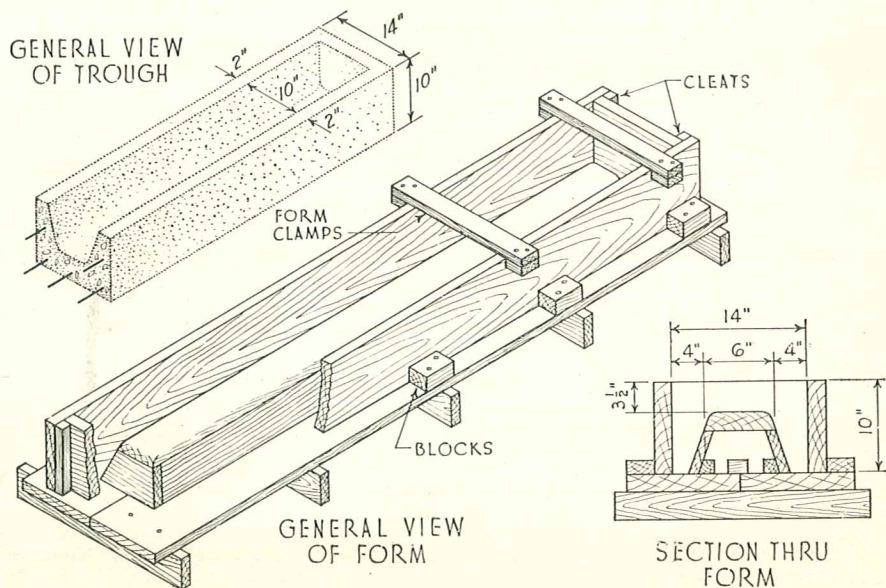

Fig. 59. Form details for building concrete hog trough.

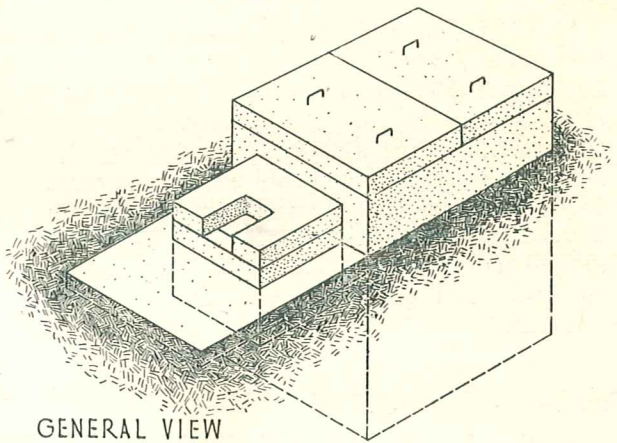
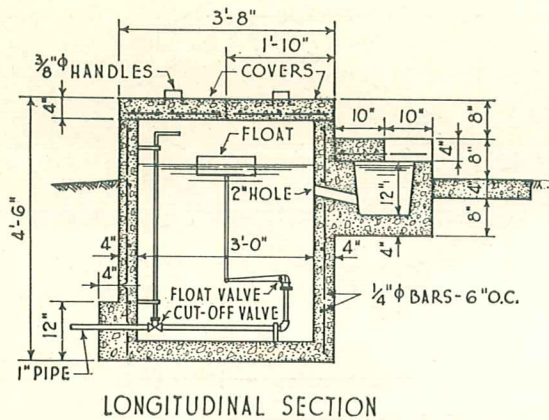
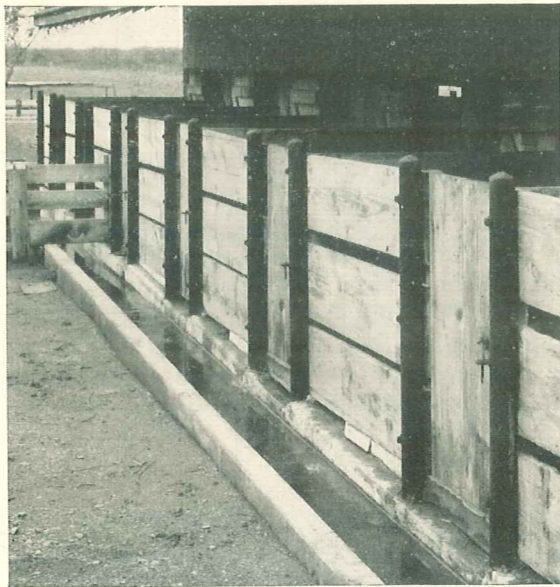

Fig. 60. Plans for an automatic concrete waterer for hogs.



This durable, long-lasting concrete hog trough was cast in place with the adjoining paved runway or feed lot floor.

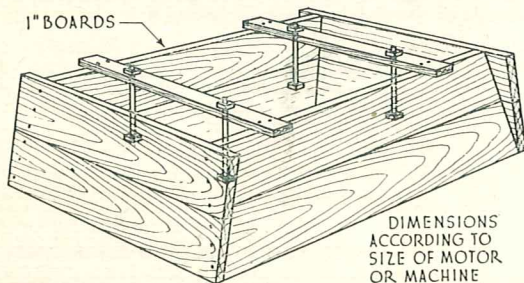
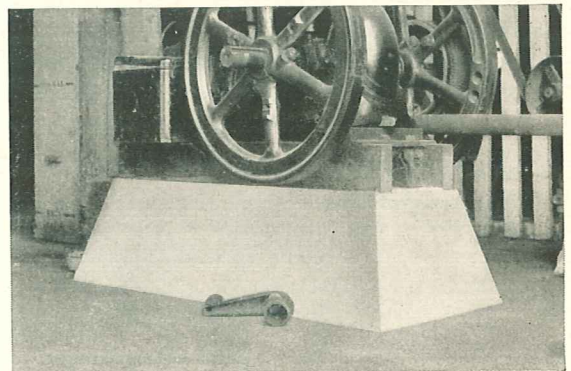

Fig. 61. Forms for concrete bases for motors, engines and other machinery.

Concrete Bases for Engines and Motors

Solid concrete bases for electric motors, gas engines and other machinery reduce vibration to a minimum, thus improving machine performance and reducing maintenance and repair.

Method of forming the concrete base is illustrated in Fig. 61. Anchor bolts for holding the engine or motor in place are set in the fresh concrete, care being taken to locate the bolts accurately. This can be done by supporting the bolts in the proper positions with crosspieces as shown in the drawing, or a templet of stiff paper may be made as a guide in spacing the anchor bolts. It is well to recheck measurements to make certain that the bolts are in the exact positions required. As indicated in Table I the suggested concrete mix for engine bases is 1 sack portland cement to $2\frac{3}{4}$ cu.ft. sand to 4 cu.ft. gravel.



Solid concrete bases are advantageous for electric motors, gas engines and other machinery because they reduce vibration and, therefore, prolong life of the machine.

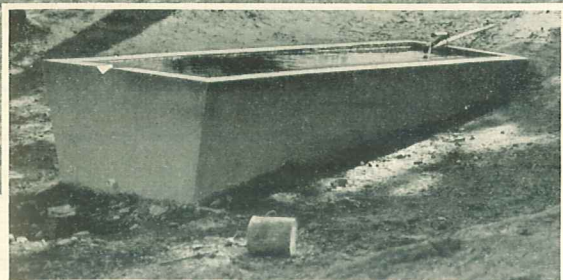
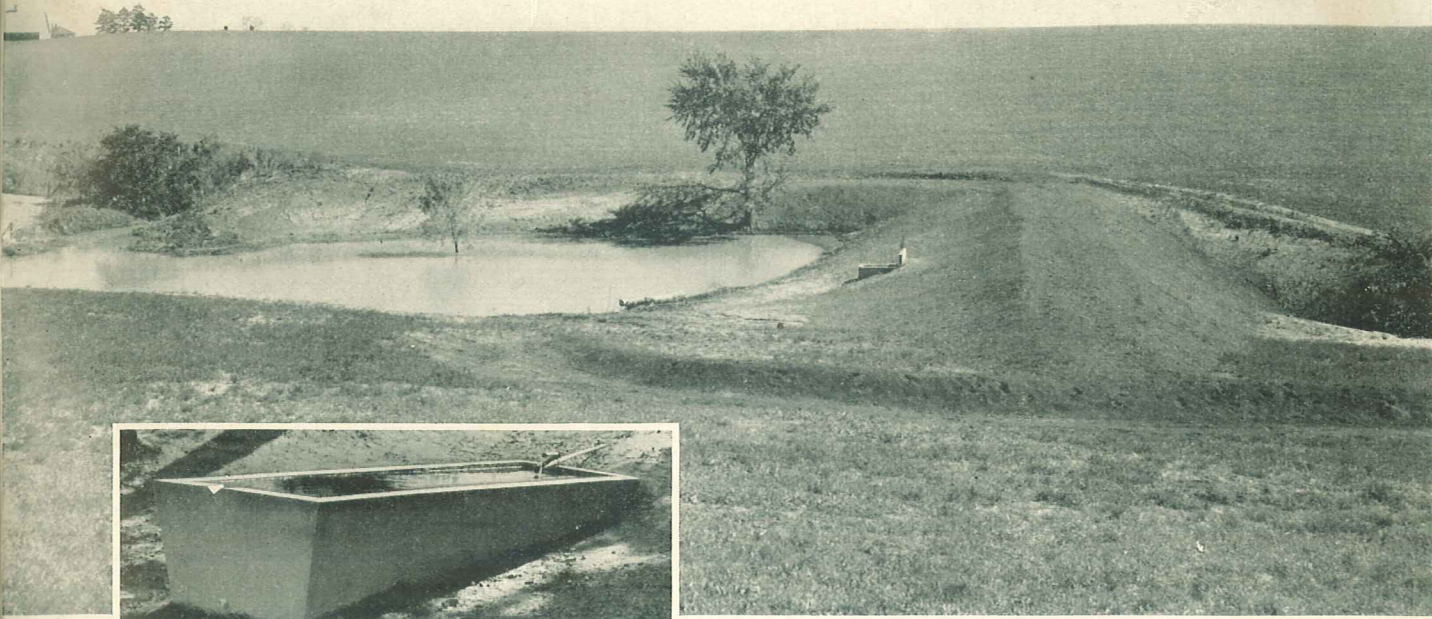

Generous supplies of water for livestock can often be created with an earth dam and a concrete tile outlet or spillway. Livestock should be fenced out of the pond area and away from the dam so that these improvements will not be injured. Water is then piped to a concrete stock watering tank below the dam as shown at the left.

Soil Erosion Control and Water Conservation

Water, properly controlled, is one of the farmer's best friends. Uncontrolled it is a dangerous robber of soil fertility, and it often causes gulleys which gradually erode and destroy much productive farm land.

Ordinarily, however, effective control of runoff water is not difficult. The photographs here show several typical examples of concrete structures which provide safe and permanent control of water. In cases of long, wide drainageways which have gentle slopes, the water usually may be controlled by keeping the drainage channel in

permanent pasture or hayland. Where drainage is concentrated, however, and water is dropped sharply to a lower level, the eroding action of the water can only be rendered harmless if the water is dropped on concrete or other masonry. Grass crops are not ordinarily practical for this purpose. Experience shows that where even small, sharp overfalls are put into grass, there is need

This cast-in-place concrete dam has permanently stopped destructive gullyng and created a farm pond valuable for stock water supply.

This earth dam with its substantial concrete spillway was built in 1910 to control gully erosion that threatened to divide a valuable farm. After more than 30 years this structure is effectively controlling the gully and protecting the farm with virtually no maintenance or repair.





Reinforced concrete check dams stop gullying action and gradually fill in drainageways above the dams.



Shallow reinforced concrete spillway or flume for an earth dam which is filling in and leveling a barnyard that was becoming seriously eroded.

for constant maintenance and repair, and many of the grassed waterways fail entirely.

Several simple designs for permanent concrete erosion control structures are available free on request in U. S. and Canada. The most common uses of concrete in erosion control on farms are for small check dams, terrace outlets, soil-saving dams, flumes, tile outlet structures.

Conservation of water for the land and for stock watering is also an important problem on many farms. Here again farmers find advantageous use of concrete in building safe and permanent outlet structures for farm ponds and for

the construction of concrete stock watering tanks below the pond. Construction details and a practical layout for stock water supply from farm ponds is also available without cost on request. These plans and construction suggestions describe how to build a complete system including an earth dam with its side spillway, the method of piping water and how to build the concrete stock watering tank which is fed from the pond.



This low-cost concrete flume is constructed by placing a 5-in. thickness of concrete on a carefully formed slope.

INDEX

Approaches, barn	49	Flower pots, boxes, urns	43
Automatic waterer, for hogs	67	Flumes, erosion control	69
Barnyard pavement	14	Footings, construction, size of	16
Basement walls	18	Form construction	17
Bases, for motors, engines	68	Foundation	
Benches, lawn	41	for engines, motors, machines	68
Bins, grain	60	walls	17
Bird bath	42	Frames, window and door	23
Block, concrete building	19	Game courts	45
Bridges, small farm	51	Grain bins	60
Bull pen	61	Grape arbor (vineyard) posts	56
Bunks, cattle feed	66	Gravel for concrete	5
Cattle feed bunks	66	Hog trough and automatic waterer	67
Cave, storage	46	Hog wallow	66
Cellar		Hotbeds	46
storage	46	Insulated cooling tank	58
wall construction	18	Lawn	
Check dams, erosion control	69	bench	41
Chimney caps	47	furniture	41
Cisterns		Lightweight concrete masonry	24
fire	49	Lily pools	44
household water supply	30	Lintels	23
Cold frames	46	Loading ramp	50
Concrete		Mailbox post	57
colored	40	Manure pits and tanks	62
how to make it	5	Materials	
how to figure materials required	10	how to figure amounts required	10
how to paint	25	Milk cooling tank	58
cold weather precautions	9	Mortar, how to make it	22
Concrete masonry construction	19	Paddock, bull	61
Construction joints	8	Painting of concrete	25
Courts, play	45	Plaster, portland cement	26
Dams, erosion control	69	Play courts	45
Dipping vats	65	Ponds, farm	69
Driveways	48	Porch floors	38
Electric fences	56	Posts	
Engine base	68	clothesline	56
Erosion control structures	69	corner	55
Farm ponds	69	electric fence	56
Feed bunk, cattle	66	fence	53
Feeding floors	14	gate	55
Fence posts	53	mailbox	57
Fire cisterns	49	sign	57
Fish pools	44	vineyard	56
Flagstones	39	Pools, lily	44
Floors		Privy, sanitary	33
construction	11	Pump pits	29
feeding	14	Pump platforms	27
how to make dry	13		
porch	38		

Ramps, loading	50	Trench silo construction	63
Ratproofing	59	Trough, hog	67
Reinforced concrete	9	Urn, concrete flower	43
Retaining walls	52	Vegetable matter test	7
Sand for concrete	5	Walks	
Septic tanks	34	flagstone or stepping stone	39
Sewage disposal	34	plain concrete	13
Shuffleboard courts	45	Wallow, hog	66
Sills, concrete	23	Walls	
Silo, trench	63	basement, watertight	18
Silt test	6	construction of	17
Soil-saving dams	69	retaining	52
Spring protection	28	yard	63
Stepping stones	39	Washing table, aggregate	6
Steps, concrete	37	Water	
Stock watering tanks	31	conservation of	69
Storage cellar	46	in concrete	5 and 7
Stucco finishes	25	requirements, household and livestock	30
Tanks		supply protection	27
liquid manure	62	Waterer, automatic, for hogs	67
milk cooling	58	Watertight concrete	10
stock watering	31	Well curbs and platforms	27
Terrace outlet	70	Window	
Tile		frames	23
concrete building	19	sills	23
outlet structures	69	Yard pavements	14
sewage disposal	35		
Tree surgery	45		

