

These guidelines were developed by the Spokane City/County Historic Landmarks Commission. The publication was financed in part with Federal funds from the National Park Service, Department of the Interior administered by the Washington State Department of Community Development (DCD) Office of Archaeology and Historic Preservation (OAHF) and the Spokane Regional Council's Historic Preservation Office. Regulations of the U.S. Department of the Interior strictly prohibit unlawful discrimination in departmental Federally Assisted Programs on the basis of race, color, national origin, age or handicap.

The contents herein do not necessarily reflect the views or policies of the Department of the Interior, Department of Community Development, or the Office of Archaeology and Historic Preservation.

Additional copies are available through the Spokane City/County Historic Preservation Office Published 1993

We should be concerned about the future  
because we will have to spend the rest of our  
lives there.

*Charles Franklin Kettering*

Nothing quite new is perfect

*Cicero*

Change is certain. Progress is not.

*E.H. Carr*

# Table of Contents

| BACKGROUND   | PAGE |
|--|------|
| ◦ Historical Overview .....                                  | 1    |
| ◦ Map of Corbin Park Historic District .....                 | 3    |
| ◦ Building Styles on Corbin Park.....                        | 4    |
| ◦ Purpose of Design Guidelines.....                          | 8    |
| ◦ The Certificate of Appropriateness .....                   | 9    |
| ◦ Projects Not Requiring a Certificate .....                 | 9    |
| ◦ Projects Requiring a Certificate.....                      | 10   |
| ◦ The Application Process.....                               | 11   |
| <br>DESIGN GUIDELINES  |      |
| ◦ General Principles for Historic Rehabilitation.....        | 12   |
| ◦ Setting and the Urban Streetscape.....                     | 13   |
| ◦ Materials and Details.....                                 | 20   |
| ◦ New Construction.....                                      | 25   |
| <br>CONCLUSION.....  | 28   |
| <br>APPENDICES   |      |
| ◦ Sample Application for Certificate of Appropriateness..... | 29   |
| ◦ Resources and Source Materials .....                       | 30   |
| ◦ Credits .....  | 32   |

BACKGROUND

# Historical Overview

In the early years of the twentieth century, a wide variety of architectural fashions characterized neighborhoods in communities like Spokane. At Corbin Park, the Park itself furnished the focal point for all future development. Houses erected around the Park's perimeter maintained careful orientation to this central element, and the rhythm created by uniform setbacks and tree-lined streetscapes serves to reinforce the cohesive image and ambiance of the Corbin Park Historic District.

Construction of the first homes around the Park commenced in 1899. Continuing at a rapid pace until 1914, 68 of the 83 homes in the District were completed before the beginning of World War I. The owners included attorneys, physicians, real estate developers, architects, two of Spokane's mayors, lumber company representatives, and business proprietors. As a neighborhood of choice for many of Spokane's prominent early citizens, Corbin Park provides a significant reflection of turn-of-the-century residential development in this community.

The residences around the Park encompass a wide range of architectural styles, from the Queen Anne and Tudor Revival, to examples of the Craftsman, American Foursquare, and the highly popular Bungalow style. Many of the buildings around the park were architect-designed, boasting the work of such prominent local figures as W.W. Hyslop, Kirtland Cutter and Karl Malmgren, C. Ferris White, and C.B. Seaton. Corbin Park also includes at least one Ballard Plannery residence, as well as the work of architects Hallett and Rawson of Des Moines, Iowa.

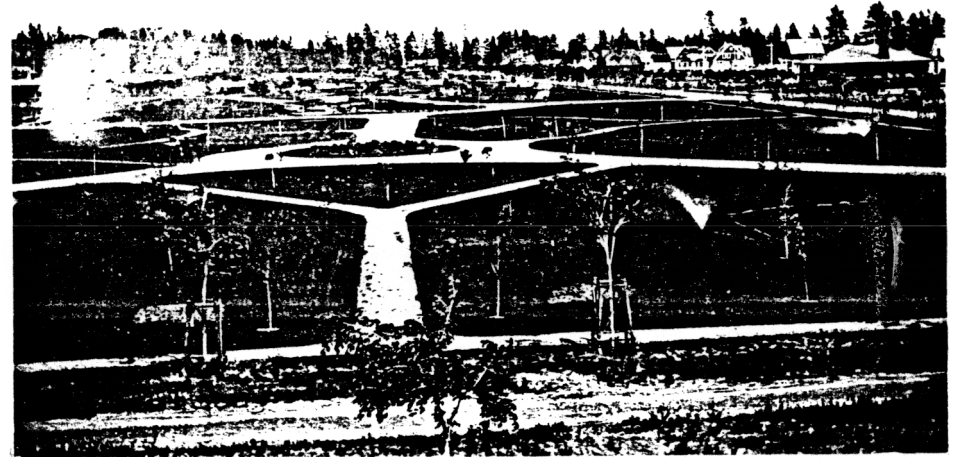

Corbin Park looking east

1904

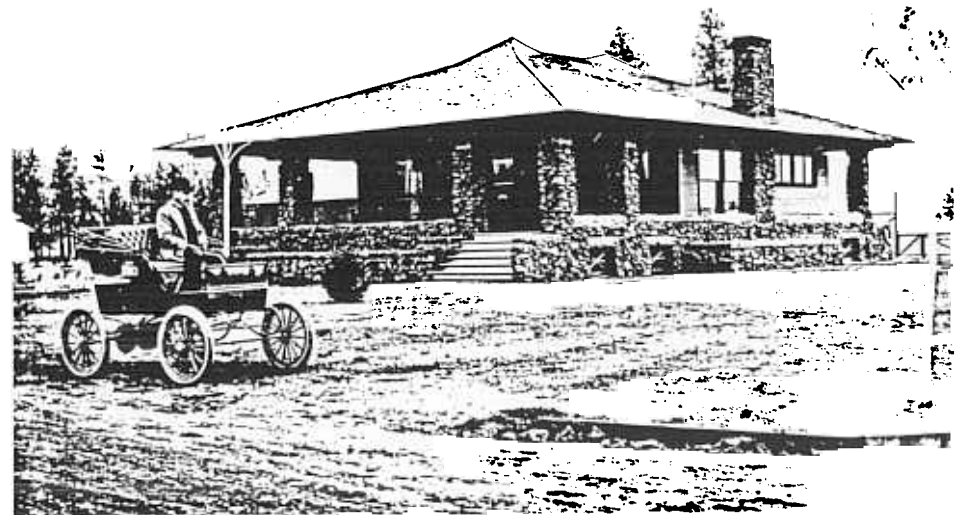

525 Waverly Place

1904

Not all of the houses around Corbin Park can be easily classified as pure examples of a specific architectural style. Many demonstrate a strong vernacular influence, drawing details from a variety of sources and often using building materials native to the area. Indeed, it is this rich array of detailing that most contributes to the distinctive quality of the Corbin Park neighborhood.

In January 1991 the Spokane City Council officially approved listing of the Corbin Park Historic District in the Spokane Register of Historic Places. Although Spokane has a number of neighborhoods listed in the National Register of Historic Places, Corbin Park became the

first district to be designated in the Spokane Register. This public recognition of the area's historic character and architectural integrity reflects the commitment of Corbin Park residents to preserving this significant Spokane neighborhood.

As a result of designation, the Spokane City/County Historic Landmarks Commission now has the authority to review and regulate proposed changes in the District, including both new construction and alterations to existing buildings located within the District's official boundaries. These design guidelines supersede other chapters and inconsistencies in the Spokane Municipal Code.

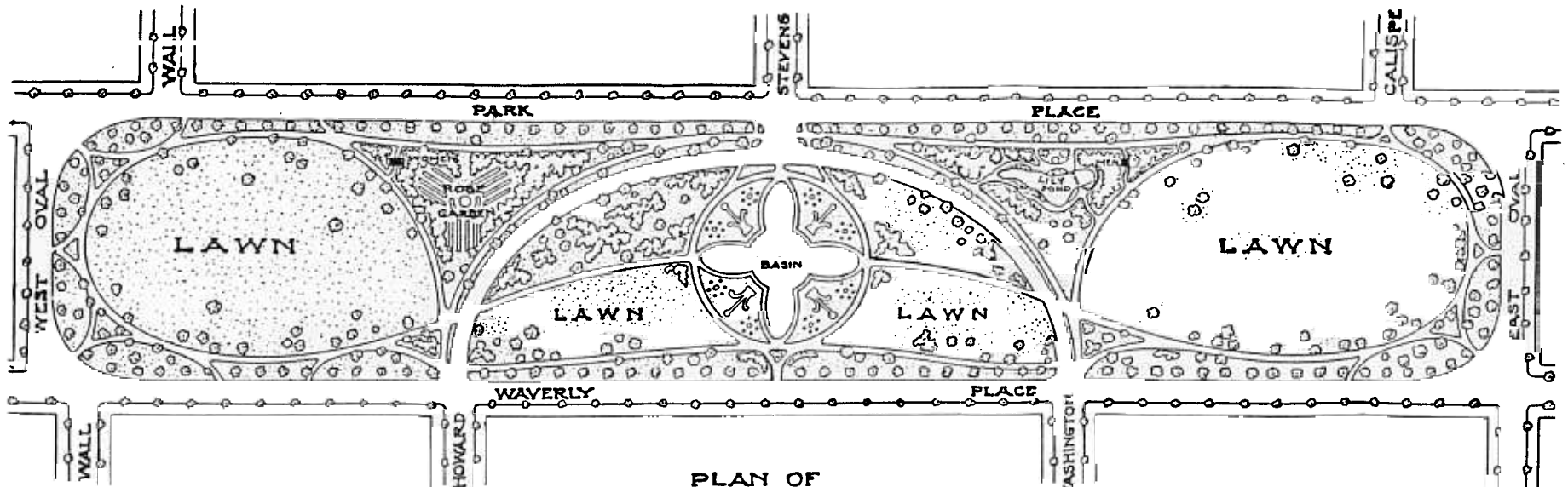

PLAN OF  
CORBIN PARK

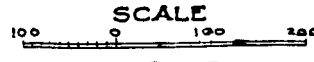

OLMSTED BROTHERS LANDSCAPE ARCHITECTS  
BROOKLINE MASS. FEB. 1909.

# The Corbin Park Historic District

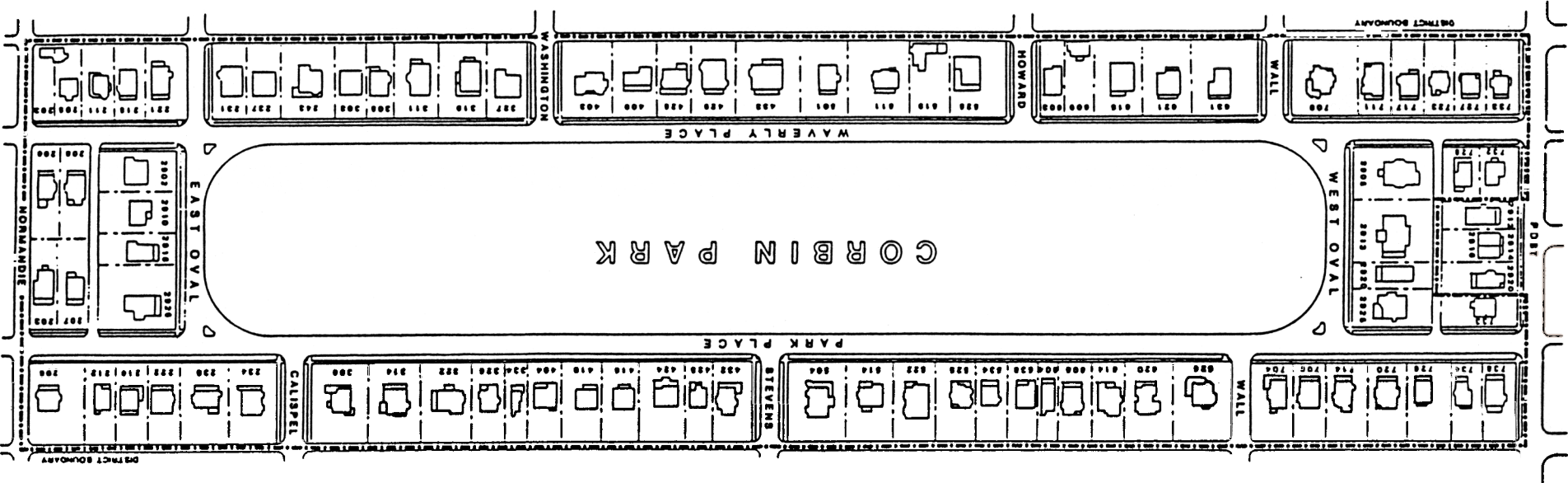

DRAWN SCALE: 1"=100'  
 GRAPHIC SCALE  
 0 25 50 100 200 FEET  
 © R.A. HAYES, P.E. - REVISED MAY 1991 HAS INCORPORATED, A.L.



# Building Styles on Corbin Park

## Queen Anne

Corbin Park's only example of this style is 709 Waverly Place. Characteristics typical of the style include:

- complexity of shape and asymmetrical facade;
- steeply pitched roof of irregular shape;
- partial or full-width, asymmetrical porch; and
- textured wall surfaces.

## Tudor Revival

Both 628 Park Place and 424 Park Place are examples of the Tudor Revival style. The following elements are typical:

- steeply pitched roof, usually side-gabled;
- tall, narrow windows, usually in multiple groups with multi-pane glazing;
- facade dominated by steeply pitched gables;
- massive, and often decorative, chimneys; and
- decorative half-timbering.



709 Waverly Place

1902



628 Park Place

1909



## Colonial Revival

Houses on Corbin Park which exhibit Colonial Revival detailing include 2913 West Oval. Features indicative of the style include:

- symmetrically balanced facade;
- double-hung windows often grouped in pairs, with multi-pane glazing in one or both sashes; and
- front door accentuated with fanlights, sidelights, and/or decorative pediment.



2913 West Oval

1904

## Dutch Colonial Revival

The Dutch Colonial Revival style is very similar to Colonial Revival in its detailing. With its use of the characteristic gambrel roof, the house at 734 Park Place provides a good example of the style. In identifying the Dutch Colonial influence, look for:

- Colonial Revival details; and
- a gambrel roof form.



734 Park Place

1910

## Craftsman

Particularly popular in the residences around the Park is the Craftsman style. Examples include 243 Waverly Place, 525 Waverly Place, and 230 Park Place. Characteristic elements include;

- low-pitched gable roof;
- wide, overhanging eaves;
- decorative beams or braces at the gables;
- roof rafters usually exposed; and
- partial or full-width porches with supporting square posts.



243 Waverly Place

1909

## Bungalow

Although the true bungalow is a one or one-and-one-half-story residence, this building style became so popular that builders often tried to make even larger houses look like bungalows. Corbin Park bungalows include 208 Waverly Place, 2905 West Oval, and 608 Park Place. Common characteristics include:

- wide eaves;
- low-pitched rooflines;
- low, wide dormers; and
- porches as extensions of living space.



608 Park Place

1914

## American Foursquare

The unpretentious American Foursquare was extremely popular at the turn of the century. At Corbin Park, examples are 433 Waverly Place and 511 Waverly Place. Common characteristics to look for include:

- low-pitched, hipped roof;
- two stories with rectangular or square plan;
- heavy eaves;
- full-width, one-story front porch; and
- one or more symmetrically placed dormers.



433 Waverly Place

1908

# Purpose of Design Guidelines

Spokane's older neighborhoods represent one of the City's finest assets. Convenient locations, strong neighborhood identity, historic parks, majestic street trees, and distinctive architectural character all contribute to the appeal of these legacies of Spokane's early growth and prosperity.

While the historic qualities of Spokane's older neighborhoods make them distinctive and appealing, change is inevitable. Design guidelines provide an effective tool for ensuring that future changes in Spokane's historic neighborhoods will not destroy their basic character and integrity. Design guidelines recognize and help to protect the elements that characterize a neighborhood. They apply both to alterations to existing structures and to new construction in an historic district. Created to manage change, these guidelines furnish a "road map" for homeowners to follow when making development decisions.

## DESIGN GUIDELINES DO NOT:

- limit growth or development within the district;
- apply to routine maintenance or to work which does not visibly affect the district, such as interiors;
- dictate design considerations which are based on arbitrary, inconsistent decisions; or
- restrict creative design solutions.

## DESIGN GUIDELINES DO:

- manage change;
- aid homeowners, architects, developers, and others by providing clear and specific guidance;
- preserve neighborhood character and integrity;
- preserve neighborhood quality of life and livability;
- provide a clear and objective basis for review of development; and
- increase public awareness of the district and its significant characteristics.

# The Certificate of Appropriateness

The Certificate of Appropriateness provides official notice that the Historic Landmarks Commission, or its designee, has approved proposed exterior changes, alterations, and/or new construction within the neighborhoods listed in the Spokane Register of Historic Places. The design guidelines provided herein will assist the property owner in making decisions about compatible improvements; they also provide the Commission with a standard for evaluating such projects.

## PROJECTS NOT REQUIRING A CERTIFICATE

Normal maintenance or repair does NOT require a Certificate of Appropriateness, if no change is made in the appearance of a building or its grounds. Such projects include:

- painting or staining (same color), except masonry;
- replacement of window glass, but not replacement windows;
- caulking and weatherstripping;
- pruning trees and shrubbery, and removal of trees less than six inches in diameter;
- minor landscaping, including vegetable and flower gardens, shrubbery, and the addition of side and rear yard trees;
- repairs-in-kind, as long as replacement materials match the original or existing materials in color and detail;
- replacement of missing or deteriorated siding, trim, roof coverings, porch flooring, or steps as long as replacement materials match the original or existing materials in color and detail;
- replacement of existing gutters and downspouts, as long as the new gutters match the profile of those being replaced and the color matches the house trim;
- erection of temporary signs, including real estate and political signs; and
- interior improvements that do not alter the exterior appearance of the building.

# Projects Requiring a Certificate

## MINOR WORK

Minor work projects require a Certificate of Appropriateness. The Historic Preservation Officer, however, as designee of the Historic Landmarks Commission, can approve the work if it is consistent with these guidelines. Minor work projects do not change the visual character of the building or grounds, and include:

- new roof coverings, where the replacement is with like materials
- landscaping projects, including the removal of trees larger than six inches in diameter; construction of patios, decks and parking areas designed to blend with the house and not easily visible from a street; fences or low walls of wood, stone, brick or cast iron that readily comply with these guidelines;
- installation of mechanical and utility equipment;
- exterior lighting fixtures which are not easily seen from a street or which are similar to those already existing in the District;
- removal of artificial siding, when the original siding is to be repaired and repainted. Siding other than the original falls under major work projects;
- removal of accessory buildings which are not original to the site or historically significant, and which cannot be easily seen from a street; and
- other minor construction not easily seen from a street

## MAJOR WORK

Major work projects must be approved by the Historic Landmarks Commission. These are projects which will substantially change the exterior appearance of a building or landscape, and may include the following:

- all new construction, including separate garages;
- any additions to buildings;
- demolition of any part of a structure;
- relocation of buildings;
- replacement of architectural details that results in a change in design, color, or materials from the original or existing;
- changes to rooflines, or changes in roofing materials or color;
- addition of parking lots, sidewalks, or driveways, unless they meet the criteria under Minor Work;
- replacement of existing windows, sash, or frames;
- changes in paint color;
- painting of original unpainted brick, stucco, or stone;
- addition of shutters not original to the building;
- exterior fire exits;
- Minor Work items not approved by the Historic Preservation Office; and
- requests for a change in use.

# The Application Process

Obtaining a Certificate of Appropriateness is the responsibility of the property owner. It is advisable to submit an application well in advance of the anticipated project and before making financial commitments for work or materials.

## The Application

The application for a Certificate of Appropriateness may be obtained from the Historic Preservation Office. A sample application is included in the Appendices.

## Receipt of Request

An application for a Certificate of Appropriateness must be submitted at least 14 days prior to the Landmarks Commission meetings at which it will be reviewed. The Commission meets on the third Wednesday of each month. The fee for a Certificate of Appropriateness is \$10.00 for the application, and \$25.00 for Commission review.

## Application Materials

For Minor Work projects, samples of proposed materials, such as siding, trim, etc., will usually be required. Photographs and sketches may also be required to describe fully the work.

Major Work projects require the following:

- statement of the proposed work;
- documentation showing existing conditions. These can include scale drawings and photographs. Documentation must also show the building in relation to its surroundings;
- scaled architectural drawings which include plans, elevations, sections and details showing proposed changes; and
- samples of all exterior materials in the proposed colors.

Applicants are encouraged to attend the Historic Landmarks Commission meeting at which the application will be reviewed. Comments are welcome at that time. Upon approval of the application, both the property owner and the appropriate city departments will be notified. If an application is denied, the applicant has the right to request arbitration by City Council or its designee. Appeal from any arbitration decision can be made to Superior Court.

# DESIGN GUIDELINES



# General Principles for Historic Rehabilitation

Adapted from the Secretary of the Interior's Standards for Rehabilitation, the following principles establish the framework for the more specific guidelines that follow. The Historic Landmarks Commission will rely on these general principles in reviewing situations that do not fall under the more specific guidelines.

1. Every reasonable effort should be made to provide a compatible use for the building that requires minimal alteration of the structure and its site.
2. Respect the original design qualities and characteristics of the building and its site. The removal or alteration of any historic material or distinctive architectural features should be avoided.
3. All buildings, structures and sites should be recognized as products of their own time. Alterations that have no historical basis and which attempt to create an earlier appearance are discouraged.
4. Changes that have taken place over time reflect the history and development of a building. Preserve older alterations that have achieved historic significance in their own right.
5. Distinctive stylistic features or examples of skilled craftsmanship which characterize a building or its site should be treated with sensitivity.
6. Deteriorated architectural features should be repaired rather than replaced, wherever possible. If replacement is necessary, the new material should match the original in composition, design, color, texture, and other visual qualities. Repair or replacement of missing architectural features should be based on accurate duplication of original elements. The design should be based on physical or pictorial evidence. Where these are not available, use design elements that reflect the style of the building.
7. The surface cleaning of historic buildings should be undertaken with the gentlest means possible. Sandblasting and other cleaning methods that will damage the historic building materials should not be undertaken.
8. Every reasonable effort should be made to protect and preserve archaeological resources affected by, or adjacent to any project.
9. Contemporary design for alterations and additions to existing properties or for new construction will not be discouraged when they do not destroy significant historical, architectural, or cultural material. New designs should be compatible with the size, scale, color, material, and character of the property, neighborhood, or environment.
10. Wherever possible, new additions or alterations should be executed in such a manner that future removal will not impair the essential form and integrity of the structure.

# Setting and the Urban Streetscape

## SETBACK & ORIENTATION GUIDELINES

Setting plays an important role in creating and preserving building character. It includes such physical characteristics as landscaping, fencing, sidewalks, and street trees, as well as the overall alignment of buildings along a street. The visual pattern or rhythm of porches, yards, and houses becomes an important urban design feature in a neighborhood. New buildings should conform to the established rhythm of setbacks and orientation to the street.



Existing Rhythm of Houses

## Historic District Cross-Section

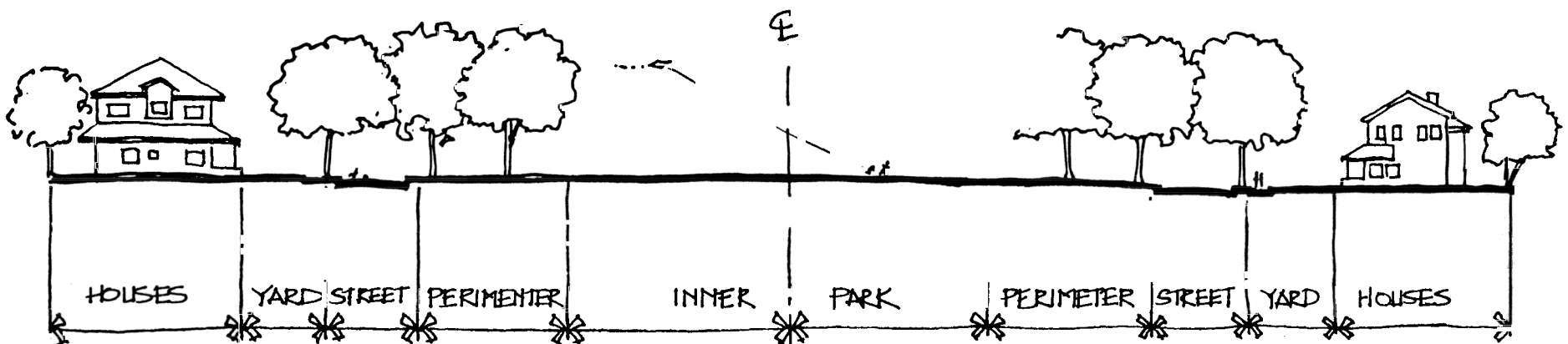

LANDSCAPING GUIDELINES

The original street tree plantings at Corbin Park represent the most significant unifying element around the Park. For this reason, restoration of the tree canopy around Corbin Park is a top priority for both the neighborhood and the Historic Preservation Office. Tree selection for the planting strips should respond to the overall plan for the neighborhood.

Original Plan 1904

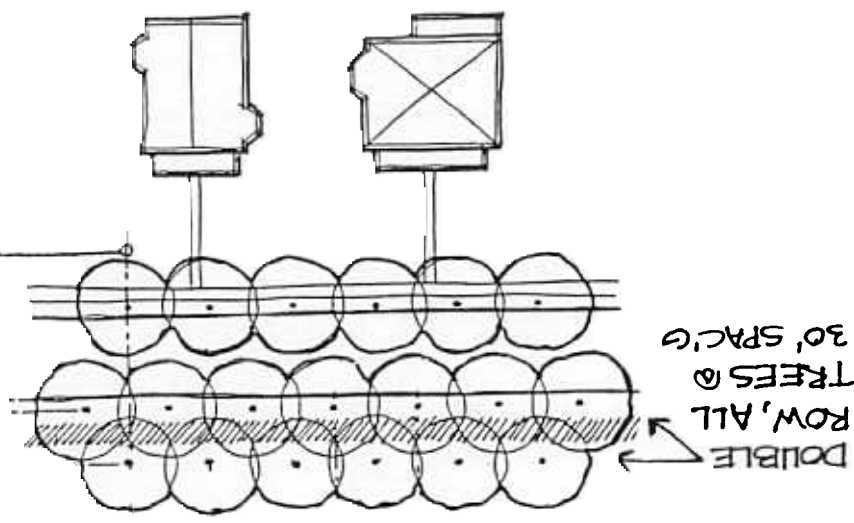

Park Replacement Plan 1993

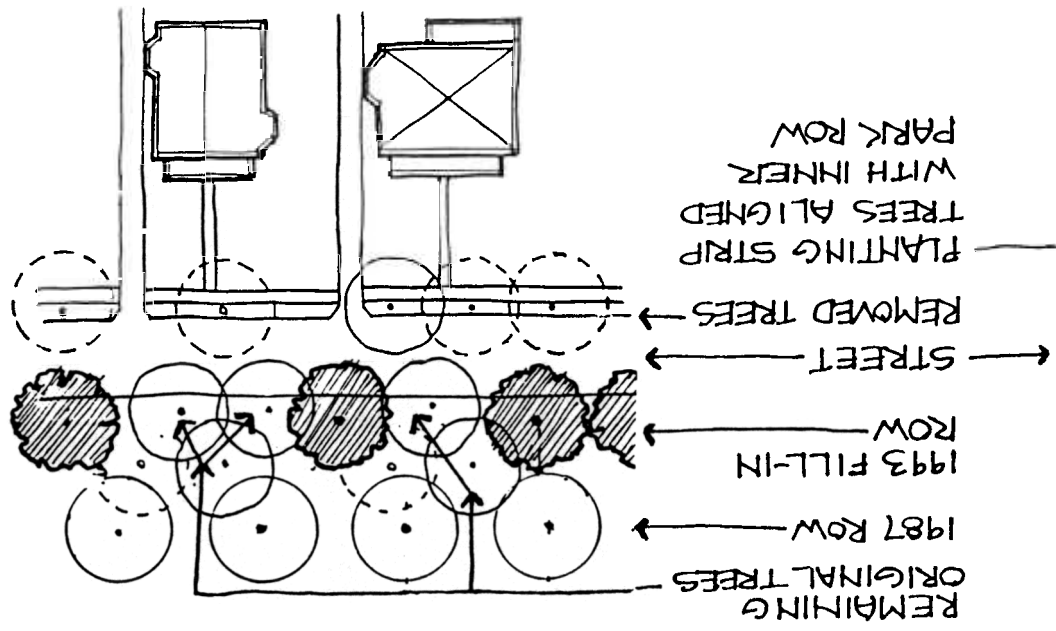

## PLANTING STRIP GUIDELINES

- Planting strips should be maintained, NOT paved or used for parking. Sidewalk repairs should be compatible with the existing walkways.

### SPECIES

- Maple varieties preferred or other broad-leaf trees with a minimum 40'-50' wide canopy at maturity.

### MINIMUM PLANTING SIZE

- 3" diameter at 3'-0" above grade.

### LOCATION

- Center of planting strip
- Min 30', max 40' spacing.
- Min 15' from driveways
- Coordinate trees at property lines with adjacent owners.

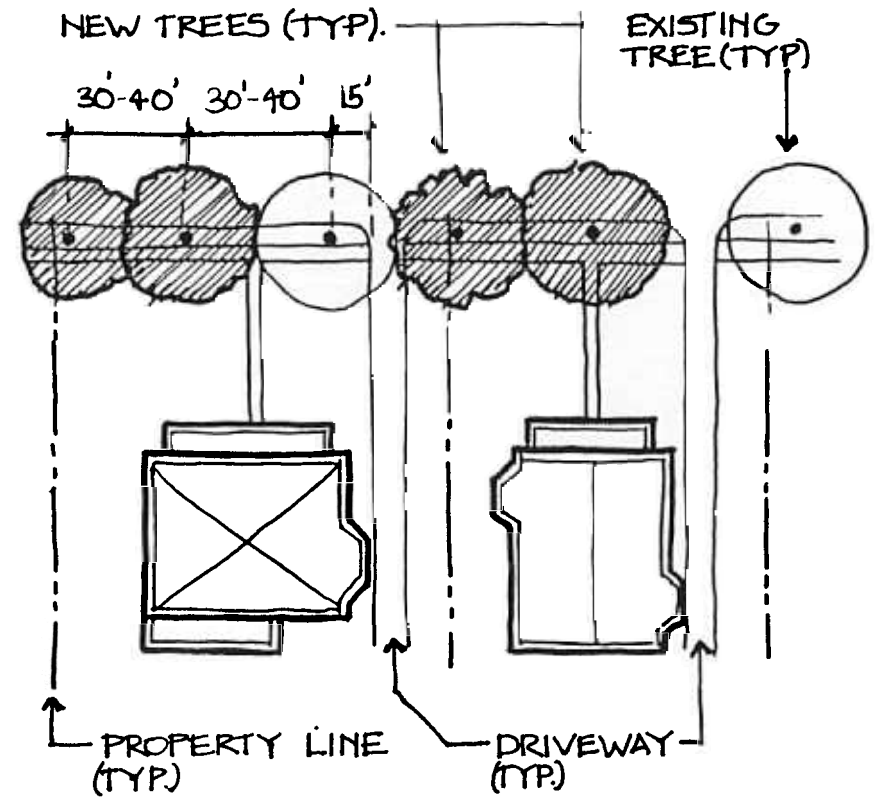

**Recommended Planting Strip Replacement**

## PROPERTY LANDSCAPING GUIDELINES

- Because landscaping establishes the mood of a residence, it should be carefully selected. Trees, bushes, and other plantings should enhance, but not hide, your house.
- New shrubbery and plantings should allow unobstructed views of buildings from the street.
- Low plantings, including 3'-4' high shrubs, annuals and/or perennials, should be used close to the house.

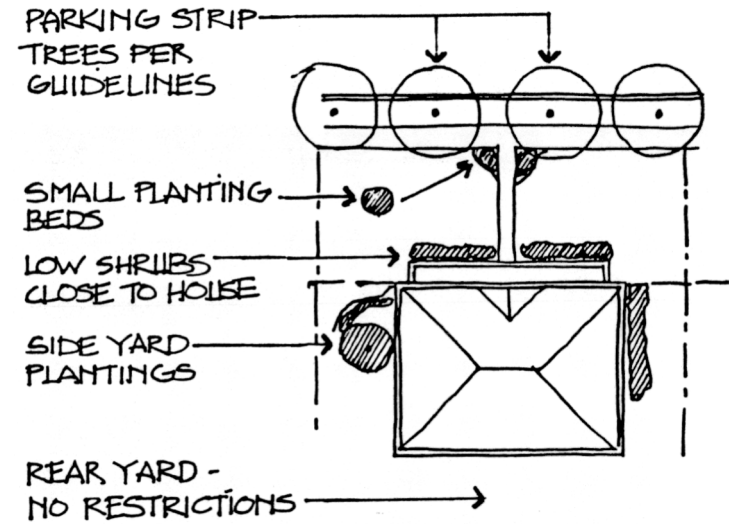

**Recommended**

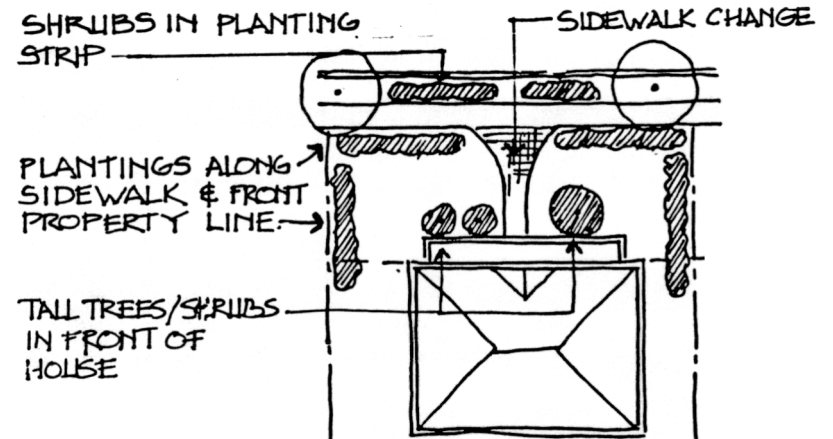

**Not Recommended**

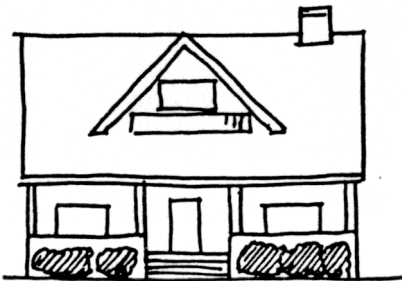

**Recommended**

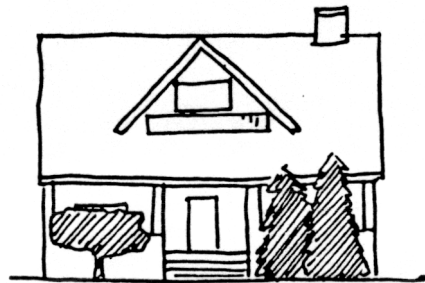

**Not Recommended**

## FENCE & WALL GUIDELINES

- Fences should be selected to harmonize with the house and street. Wooden fences should reflect traditional designs. Low stone walls are another good choice. Because of the strong relationship of the surrounding houses to front yards, fences should not exceed 4' in height in side yards on corner lots.
- Chain link fences are considered inappropriate and will be approved only for rear yards. If approved, it is suggested that property owners use vinyl cladding or dark paint to make these fences as unobtrusive as possible.



STONE

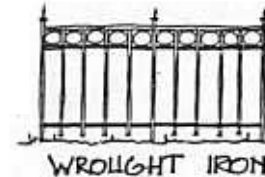

WROUGHT IRON

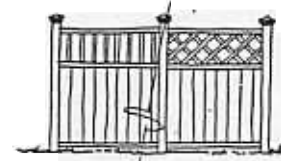

WOOD SLAT

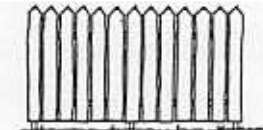

WOOD PICKET

**Recommended**

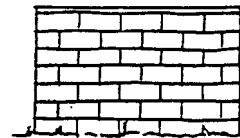

CONCRETE BLOCK



CHAIN LINK

**Not Recommended**

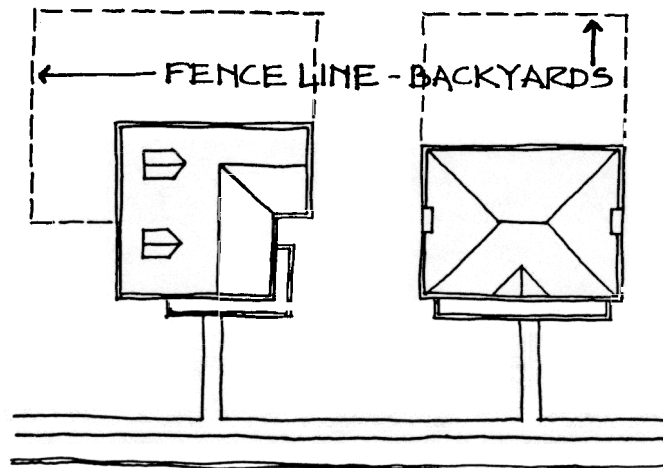

**Recommended**

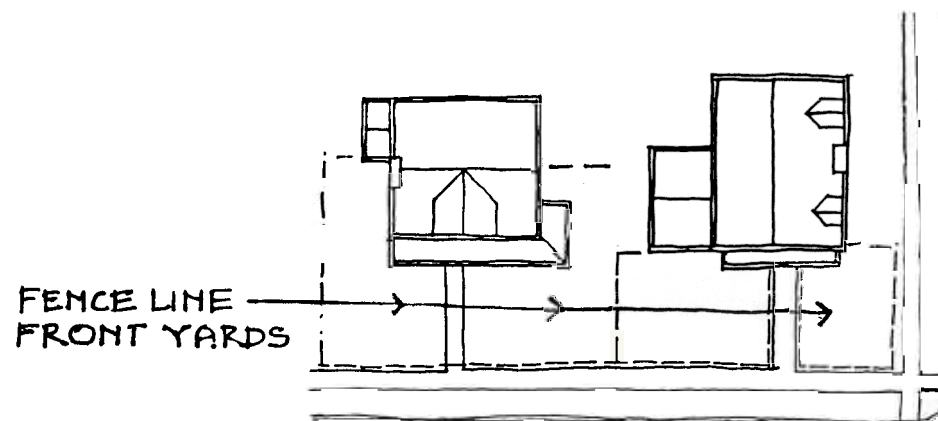

**Not Recommended**

## SIGNAGE GUIDELINES

- Signs are generally inappropriate in a residential district. If required, signs should be as small and unobtrusive as possible. Flushmounted signs are preferred. Signs placed in the yard should be small and set low to the ground.
- Wood, bronze, or similar metals are the preferred materials of choice.
- Temporary signs (i.e., real estate and political) are not subject to review.

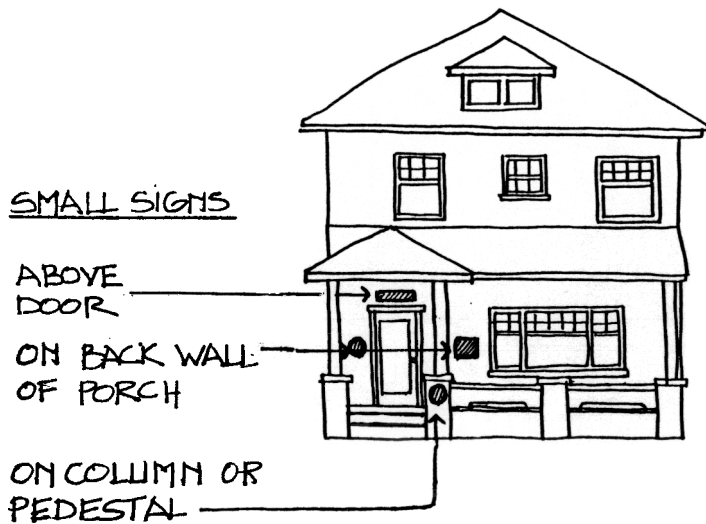

Recommended



Not Recommended

## GARAGE, DRIVEWAY, & PARKING GUIDELINES

- Original outbuildings should be maintained and preserved.
- New garages or outbuildings should be compatible with the primary residence in choice of materials, color, fenestration, and roof form.
- New garages or outbuildings should be situated to the rear of the primary residence. An attached garage or carport is inappropriate.
- Original driveway configurations should be retained whenever possible. The use of traditional alley approaches, rather than new driveways, is encouraged. The impact of new driveways on existing historic features should be minimized. Acceptable materials might include concrete brick, or pavers.

- New parking areas should be sited to minimize their impact on the main building and existing mature trees. Whenever possible, they should be located behind buildings, or to the side if screened from view.
- Wherever possible, mechanical equipment that must be placed outside existing buildings should be located out of view at the rear of the structure. It should be screened from view if placed beside a building.

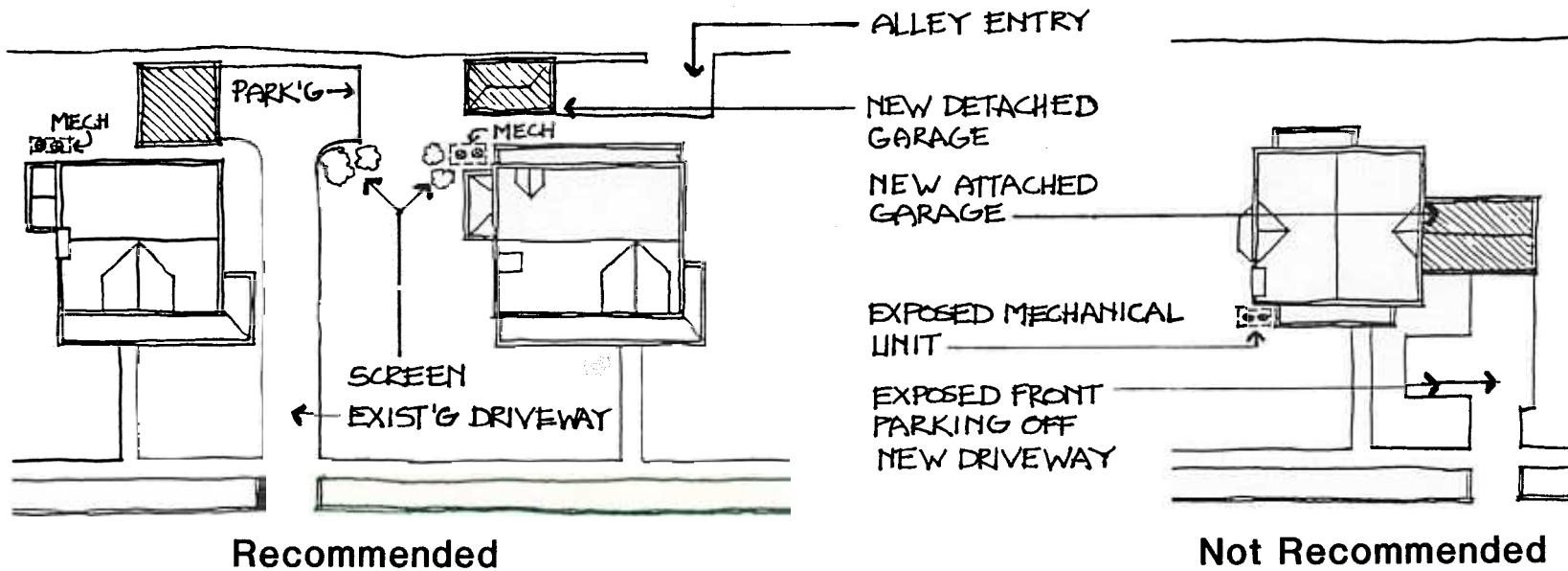



# Materials & Details

Property owners are strongly encouraged to maintain and restore original exterior features and materials. Exterior surface materials, doors, and windows are especially significant elements.

## EXTERIOR WALL GUIDELINES

Artificial siding tends to mask historic details and can actually lead to eventual damage to original fabric, if it is not properly applied. Artificial siding will not be allowed on key buildings in the District. In instances where this siding is allowed on secondary buildings, no decorative trim may be covered, and the siding must match the existing in width and detail. Artificial siding may be approved for outbuildings situated to the rear of the primary residence. Do not install insulation by drilling holes in original exterior siding materials.

## PAINT COLOR GUIDELINES

Color schemes should be appropriate for the period and style of the building; the Historic Preservation Office can suggest sources for appropriate color palettes. Unpainted masonry should remain unpainted whenever possible.

In preparing a building for painting, care should be taken to avoid damaging original materials. Sandblasting of either masonry or wood is not allowed; high pressure cleaning can also damage original materials. It is recommended that owners use the gentlest means possible to prepare surfaces for painting.

## ROOF GUIDELINES

Original roof pitches, eaves, and details should be preserved. If a replacement roof is needed, the material pattern, and color should match or closely resemble the original. Composition shingles are generally considered a suitable roofing material.

When considering gutters, the property owner should first determine if such an addition will hide original details, like exposed rafter tails. Often the roof pitch and overhanging eaves were designed to handle this function. If gutters are still desired, simple box or half-round gutters are most accurate. These should be installed without removing original crown molding.

Chimneys visible from the street should be repaired and rebuilt rather than removed. New mortar should match the original in its color and strength.

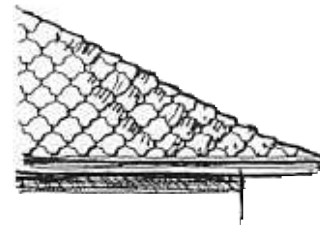

SCALLOPED

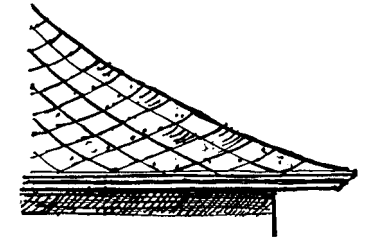

DIAMOND

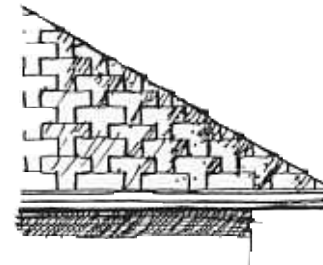

INTERLOCKING "T"

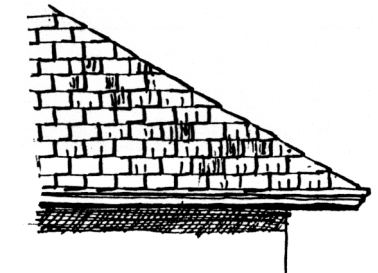

3-TAB

**Recommended**



**Typical Roof Pitches**

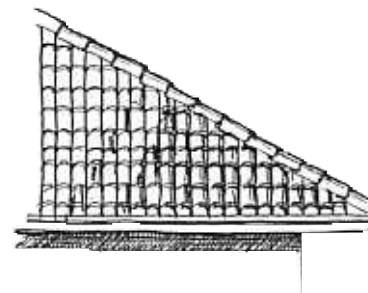

CLAY TILE

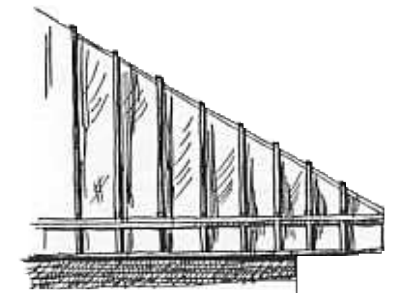

METAL STANDING SEAM

**Not Recommended  
(UNLESS ORIGINAL)**

## PORCH GUIDELINES

Porches and verandas are a significant recurring element around Corbin Park. Wherever possible, they should be preserved in their original form, along with such ornamental details as railings, posts, and brackets. Property owners are strongly discouraged from enclosing front porches.

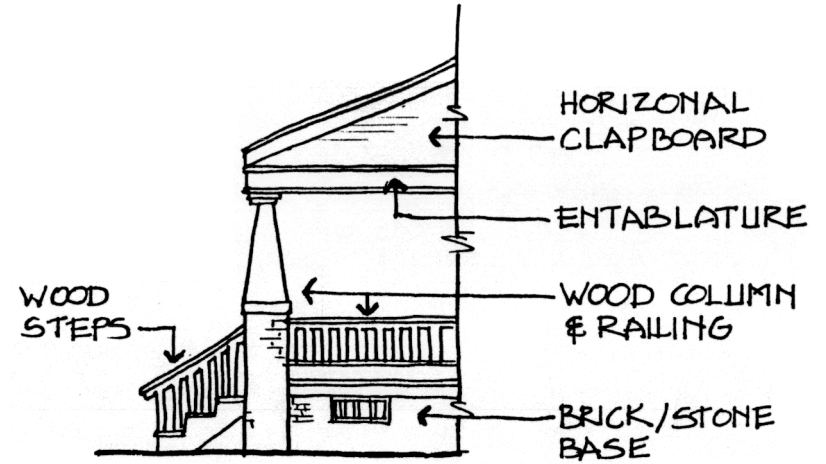

**Recommended**

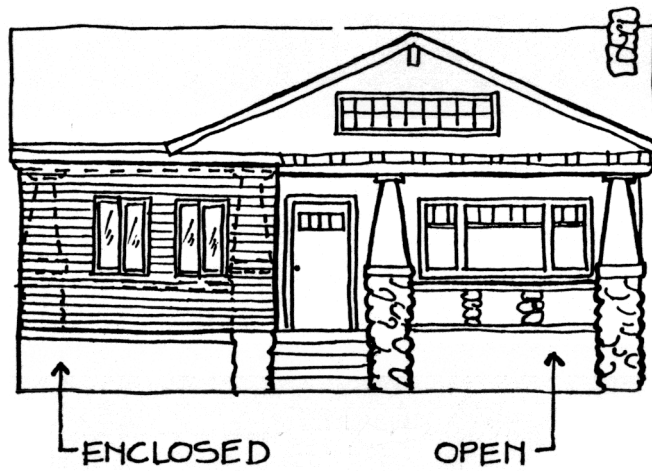

RETAIN, DON'T ENCLOSE,  
OPEN PORCHES

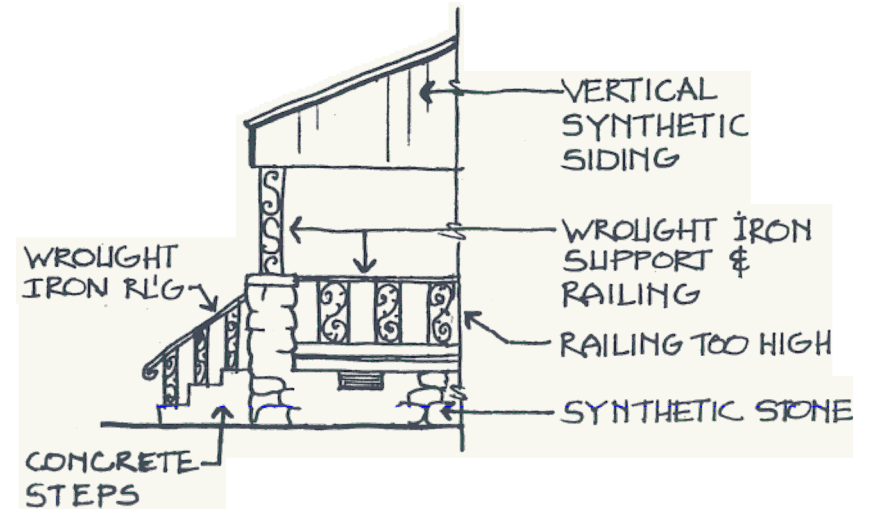

**Not Recommended**

## GUIDELINES FOR DOORS, WINDOWS, STAIRS, & OTHER HISTORIC DETAILS

Doors, windows, and entry stairs are important character-defining features of historic buildings. For that reason, these original features should be maintained and preserved whenever possible. If they must be replaced, the replacement should replicate the original in both materials and form. In instances where the original fabric has been removed, any rehabilitation should be based on photographic documentation or original drawings. If these are unavailable, the replacement elements should be sensitive to the architectural style and materials of the existing building.

Historic window proportions and materials should be maintained. If it is necessary to replace original windows, the new windows must replicate the exact appearance of the originals. This is seldom achieved using substitute materials like aluminum sash.

Historically compatible storm/screen doors are available. Storm doors should allow a full view of the main door, while storm windows should be divided with meeting rails that match the original sash. All storms should be painted to match existing trim to minimize their impact.

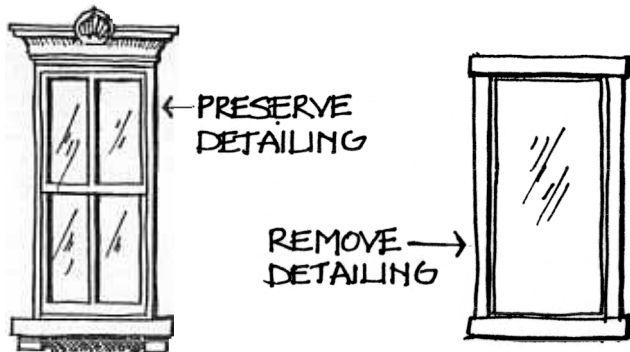

**Recommended**

**Not Recommended**

23



RETAINED WINDOWS & DOORS

**Recommended**



ALTERED WINDOWS & DOORS

**Not Recommended**

## HISTORIC ARTIFACT GUIDELINES:

Historic features such as carriage blocks, hitching posts and rings, ornamental stonary, and decorative lighting should be preserved and maintained. These elements contribute to the character of the historic setting.

# New Construction

New construction represents the most challenging design issue facing historic neighborhoods. When considering any new construction, whether primary or secondary, it is essential to stay within the existing context. This requires that consideration be given to a combination of elements: landscaping and site features; building setback from the street and orientation with adjacent buildings; building massing and scale; detail, color, and materials.

## BUILDING ORIENTATION GUIDELINES

The relationship of new construction to the street should echo existing patterns. The front facades of new buildings should be placed within the same plane as those of their neighbors. Avoid placing new buildings at odd angles to the street.

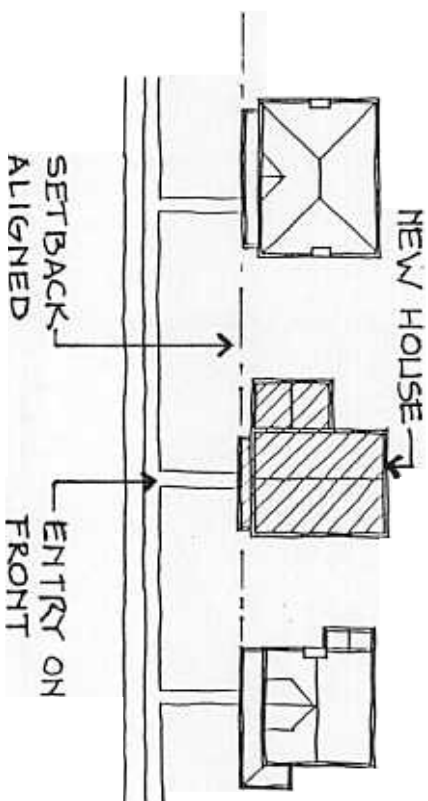

**Recommended**

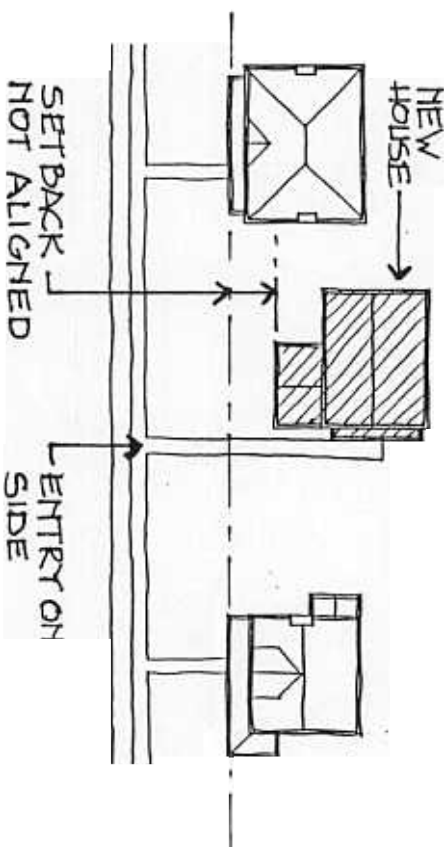

**Not Recommended**

## HEIGHT & SCALE GUIDELINES

New buildings should also be compatible with existing residences in both height and scale. A three-story, 4000 square foot house would be inappropriate in a block of 1500 square foot bungalows.

## GUIDELINES FOR BUILDING MASSING & DETAIL

Great attention must be paid to building massing and detail in new construction. Although replication of historic features is not encouraged on new buildings, the massing of new construction should be broken into the forms characteristic of older houses. Front porches oriented toward the Park represent a primary design feature in the Corbin Park area; they can be used on a new building to evoke the flavor of their surroundings while avoiding mere imitation.

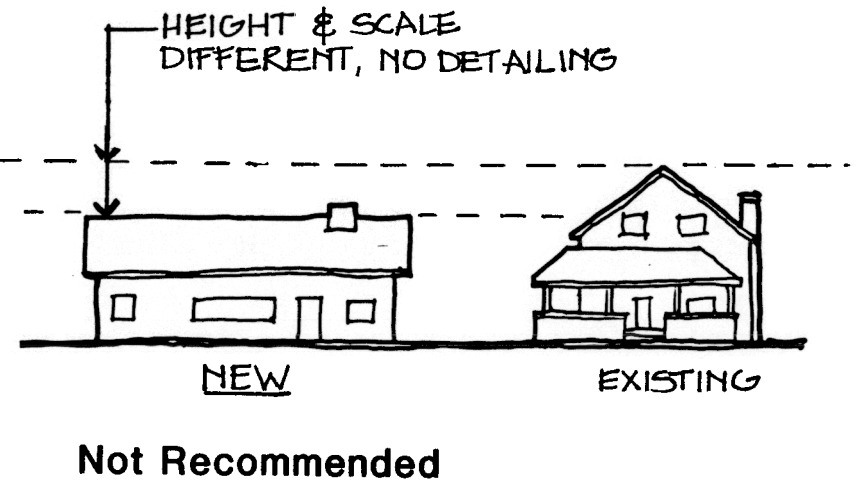
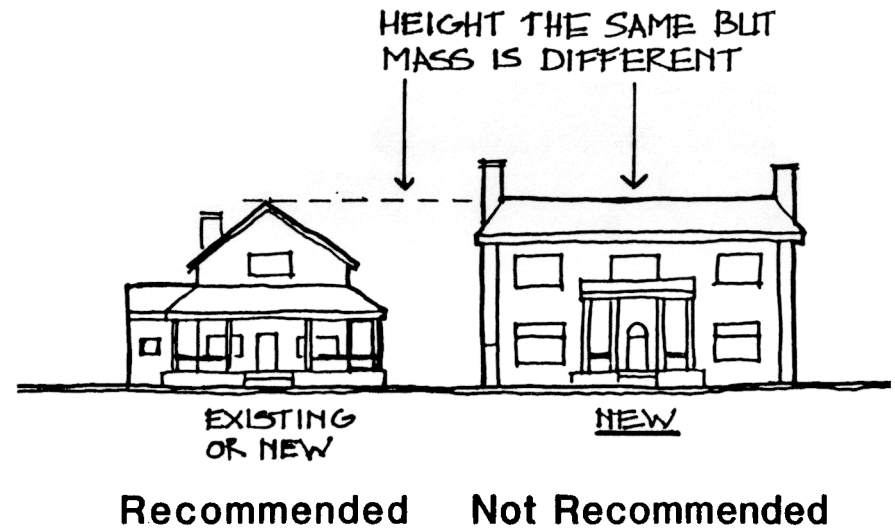

## GUIDELINES FOR NEW ADDITIONS

New additions should be subordinate to and compatible with the original building in terms of materials, roof form, and windows. They should not be attached to the primary facade.

Decks are often added to historic homes. Again, care should be taken to complement the architectural style of the house. Decks should also be limited to the rear or sides of the building.

When changes must be made to accommodate individuals with disabilities, care should be taken to minimize the impact on historic features. For example, ramp access might be provided at a secondary or rear entrance, or screened with landscaping if installed on a primary elevation. It is recommended that ramps should be of a stable, but temporary nature to allow for possible removal at a later date.

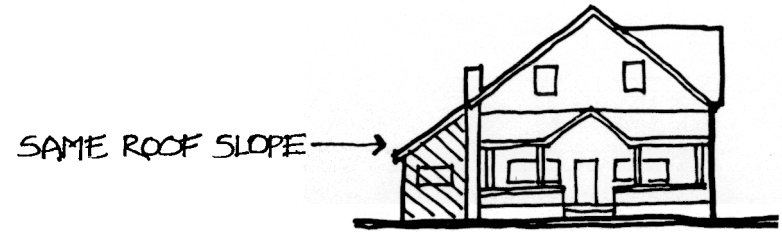

**Recommended**

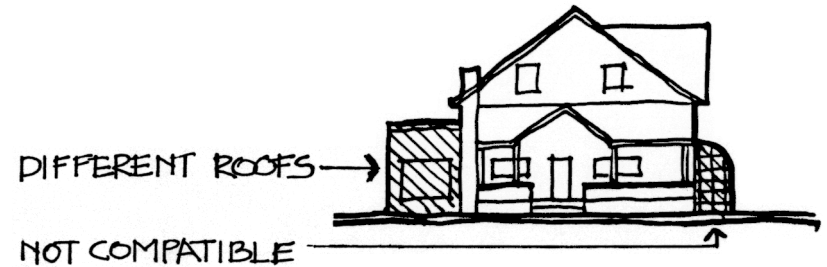

**Not Recommended**

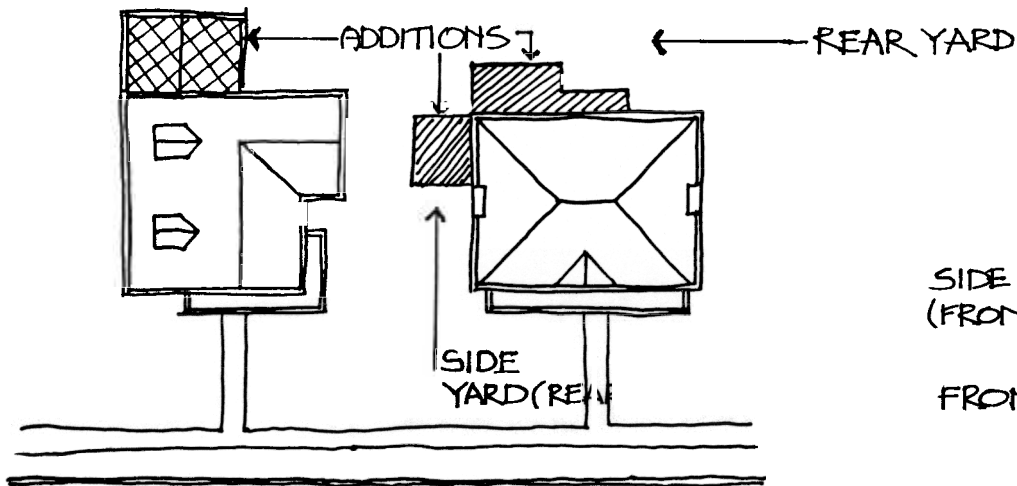

**Recommended**

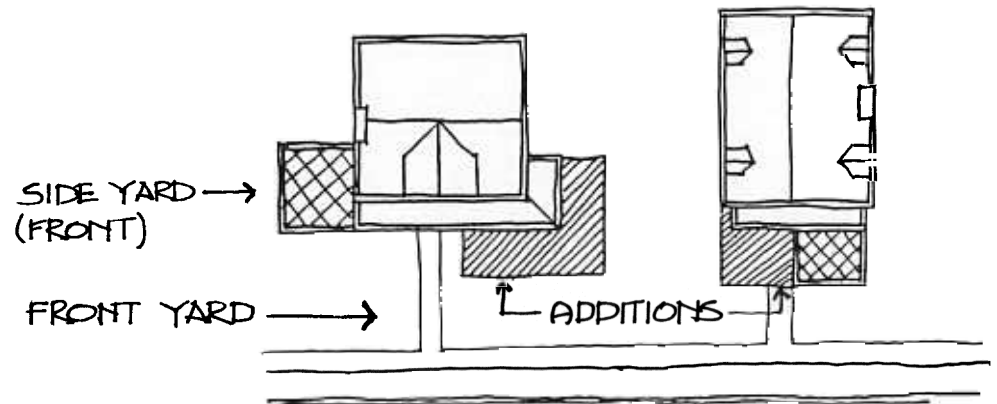

**Not Recommended**



## Conclusion

The reward of a thing well done, is to have done it.

*Emerson*

As a resident of Corbin Park, you have the opportunity to participate in the ongoing preservation and maintenance of this historic neighborhood. By following these standards, you will ensure that Corbin Park retains its distinctive architectural character and quality of life for the benefit of future generations. Use these guidelines as your guide to making appropriate development decisions, and always contact the Historic Preservation Office whenever questions arise.

# APPENDICES

# Resources & Source Materials

## Public & Private Preservation Organizations

Spokane City/County Historic Preservation Office &  
Spokane City/County Historic Landmarks Commission  
Spokane Regional Council  
W. 808 Spokane Falls Blvd., Room 627  
Spokane, WA 99201  
625-6370

Nancy Gale Compau  
Northwest Room Historian  
Spokane Public Library  
Spokane, WA 99201  
838-4737

Eastern Washington State Historical Society/Cheney Cowles Museum  
Research Library and Special Collections/Laura Arksey  
W. 2316 First Avenue  
Spokane, WA 99204  
456-3931

Friends of the Davenport  
700 Old National Bank Building  
Spokane, WA 99201

City Office of Community Development  
Second Floor, City Hall  
Spokane, WA 99201  
625-6325

County Office of Community Development  
N. 721 Jefferson, Rm. 400-402  
Spokane, WA 99201  
458-2521

Washington State Office of Archaeology and Historic Preservation/  
State Advisory Council on Historic Preservation  
111 21st Avenue, SW, Box 48343  
Olympia, WA 98504  
(206) 753-4011

Washington Trust for Historic Preservation  
204 First Avenue South  
Seattle, WA 98104  
(206) 624-7880

The National Trust for Historic Preservation  
1785 Massachusetts Avenue, N.W.  
Washington D.C. 20036  
(202) 673-4000

The National Trust for Historic Preservation  
Western Regional Office  
One Sutter Street, Suite 707  
San Francisco, CA 94104  
(415) 956-0610

Preservation Action  
1350 Connecticut Avenue, N.W. Suite 401  
Washington D.C. 20036  
(202) 659-0915

National Center for Preservation Law  
1233 20th Street, N.W. Suite 501  
Washington D.C. 20036  
(202) 828-9611

American Association for State and Local History  
172 Second Avenue N. Suite 102  
Nashville, TN 37201  
(615) 255-2971

### Bibliography

Caring for Your Old House: A Guide for Owners & Residents. Judith L. Kitchen.

Respectful Rehabilitation: Answers to Your Questions About Old Buildings. National Park Service.

The Brown Book: A Directory of Preservation Information. National Trust for Historic Preservation.

"Old House Journal"  
2 Main Street  
Gloucester, MA 01930  
(509) 283-3200

# Credits

Historic Photos courtesy of the Robert B. Hyslop Collection

Current Photos by: Mac McCandless, AIA

Graphics by: Mac McCandless, AIA and Jeff Anderson

Financial Assistance: National Park Service  
Office of Archaeology & Historic Preservation

Special Thanks to:

The Historic Landmarks Commission

David C. Shockley

Daniel E. Barrett

Richard S. Hobbs

Marsha Rooney

Sarah A. Keller

Robert Ogden

H. Allen Lewis

Steve Franks

Frank J. Gebhardt

Bette Meyer

Frederick Long

R. Ron Wells